

# Systemfedern







# Systemfederauswahl



Systemfedern stehen in farblich gekennzeichneten Belastungsarten mit unterschiedlichen Durchmessern und Längen zur Verfügung. Die Federauswahl erfolgt nach Hülsendurchmesser D, Federweg s (inkl. mind. 5% Vorspannung), Federkraft F und Lebensdauerstufe A - E. Die in den Tabellen angegebenen Werte für die Lebensdauer sind empirisch in Tests ermittelt worden. Sie hängen stark von den tatsächlichen Arbeitsbedingungen ab und sollten daher nur als Anhaltswert dienen. Federweg möglichst auf lange Lebensdauer auslegen.

## Systemfedern mit rechteckigem Drahtquerschnitt:



Norm	Modell	A 	B 	C 	D 	E 
Lebensdauer (Hübe)		+ 3.000.000	~ 1.500.000	300 - 500.000	100 - 200.000	-
-	1L extra leichte Last	30,0 %	40,0 %	45,0 %	50,0 %	ab ca. 60%
ISO 10243	1S leichte Last	25,0 %	30,0 %	35,0 %	40,0 %	ab ca. 50%
ISO 10243	2S mittlere Last	25,0 %	30,0 %	33,75 %	37,5 %	ab ca. 45%
ISO 10243	3S schwere Last	20,0 %	25,0 %	27,5 %	30,0 %	ab ca. 40%
ISO 10243	4S extra schwere Last	17,0 %	20,0 %	22,5 %	25,0 %	ab ca. 35%
-	5S super schwere Last	10,0 %	12,0 %	13,5 %	15,0 %	ab ca. 20%

 Die Lebensdauerstufe E (Block) sollte vermieden werden.

Modell	D (mm)									Lebensdauerstufe
	10,0	12,5	16,0	20,0	25,0	32,0	40,0	50,0	63,0	
Kraft (N) (Durchschnittswerte)										
NV 5 1L	60	110	140	220	410	485	745	1.560	1.290	A
	80	150	185	290	540	650	1.000	2.120	1.700	B
	90	170	205	330	610	730	1.120	2.380	1.900	C
	105	190	230	365	680	810	1.250	2.650	2.150	D
NV 5 1S	70	130	185	315	560	830	1.130	2.320	3.250	A
	80	150	220	380	675	990	1.360	2.780	3.900	B
	95	180	260	440	780	1.160	1.590	3.240	4.540	C
	110	200	300	500	890	1.320	1.810	3.710	5.190	D
NV 5 2S	110	190	330	525	845	1.520	2.030	3.050	5.310	A
	130	230	400	625	1.010	1.830	2.430	3.660	6.370	B
	150	255	450	705	1.140	2.060	2.730	4.120	7.170	C
	170	280	500	780	1.260	2.280	3.040	4.580	7.960	D
NV 5 3S	125	200	380	935	1.560	2.530	3.270	4.860	8.440	A
	155	250	480	1.170	1.950	3.170	4.090	6.070	10.560	B
	170	275	525	1.290	2.140	3.480	4.490	6.670	11.610	C
	185	300	570	1.400	2.340	3.800	4.900	7.280	12.660	D
NV 5 4S	145	230	455	1.090	1.760	2.800	4.770	6.820	11.890	A
	170	270	535	1.280	2.070	3.290	5.610	8.030	13.990	B
	195	305	605	1.440	2.320	3.700	6.300	9.020	15.740	C
	215	340	670	1.605	2.585	4.120	7.010	10.040	17.330	D
NV 5 5S	390	660	1.285	1.880	4.090	6.350	7.700	12.280	12.130	A
	470	790	1.540	2.260	4.910	7.620	9.240	14.730	14.560	B
	530	890	1.730	2.540	5.530	8.570	10.400	16.580	16.380	C
	590	990	1.925	2.825	6.140	9.520	11.550	18.420	12.800	D

### Kenngrößen:

- D Hülsendurchmesser in mm
- d Dorndurchmesser in mm
- $L_0$  Länge der unbelasteten Feder in mm
- R Federrate in N/mm
- S Federweg in mm
- F Federkraft in N
- b, h Federquerschnitt bzw. -durchmesser in mm
- A-E Lebensdauerstufe  
(abhängig vom Kompressionsgrad (%) der unbelasteten Federlänge  $L_0$ )

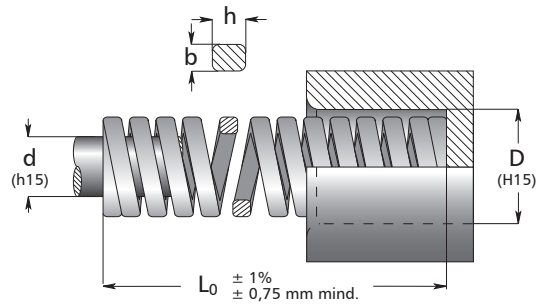

### Kraftdiagramm Systemfedern mit rechteckigem Drahtquerschnitt:

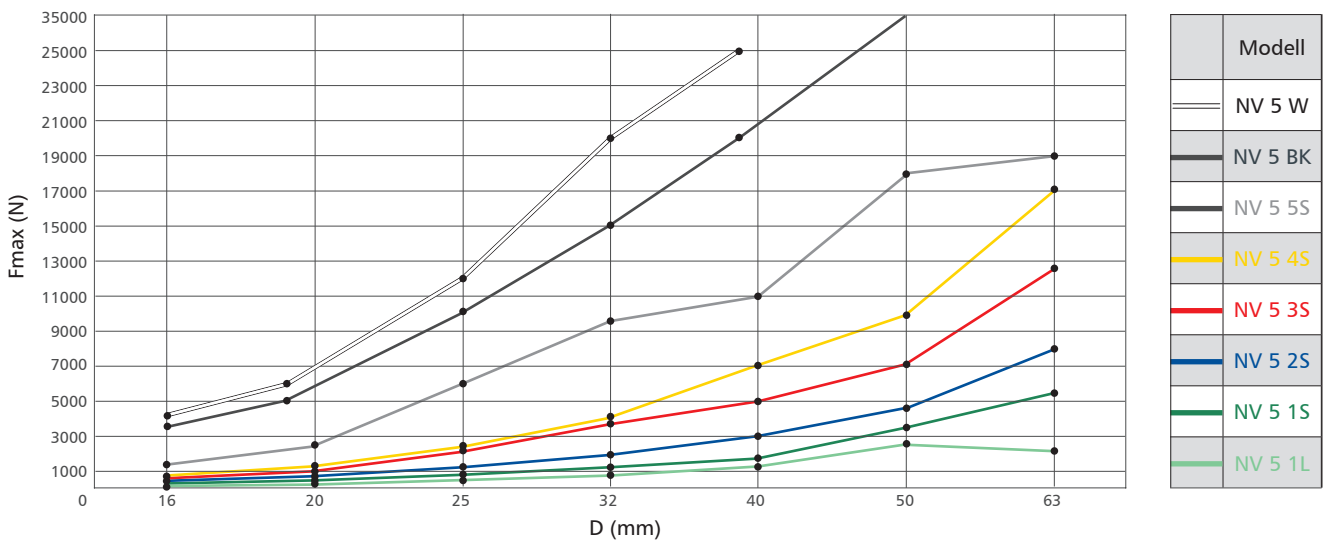

# Federrate $R \pm 10\%$

## Definition:

Die Federrate  $R$  gibt an, um wie viel Newton sich die Kraft mit jedem Millimeter zusammengedrückter Feder erhöht. Bei Systemfedern ist die Federrate linear. Die Federrate ist abhängig von Drahtstärke, Federdurchmesser, Windungsanzahl und unbelasteter Federlänge  $L_0$ .

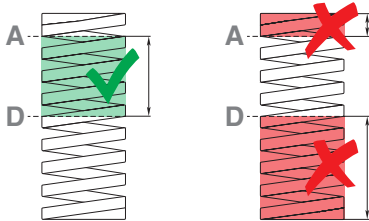

Die Federrate wird im Bereich A bis D (siehe Zeichnung links) einer Systemfeder ermittelt. Messungen außerhalb dieses Bereichs können zu Ungenauigkeiten führen.

### Ermittlung der Federrate am Beispiel NV 5 3S26025

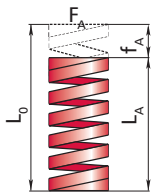

Systemfeder um  $f_A = 5 \text{ mm}$  (Spalte Lebensdauerstufe A) zur Nennlänge  $L_0$  komprimieren und Kraft  $F_A$  in N messen.

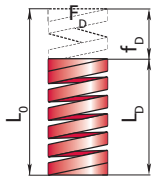

Systemfeder um  $f_D = 7,5 \text{ mm}$  (Spalte Lebensdauerstufe D) zur Nennlänge  $L_0$  komprimieren und Kraft  $F_D$  in N messen.

Berechnung der Federrate  $R$ :

$$R = (F_D - F_A) / (f_D - f_A)$$

$$R = 375 \text{ N/mm} \pm 10\%$$

### Berechnung der Kraft $F_x$ am Beispiel NV 5 3S32075

$$L_0 \pm 1\%$$

$$\pm 0,75 \text{ mm mind.}$$

$$F_x = R * f_x$$



(Federkraft beim Federweg  $L_x$ )  
 $F_x$  kann durch die Toleranzen von Federrate  $R$  und Nennlänge  $L_0$  variieren.

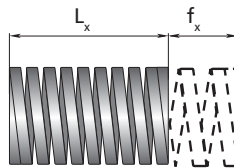

Die Berechnung ist nur korrekt, wenn die Federwegswerte der Spalten A und D verwendet werden.

Berechnung Nominalwert  $F_{x \text{ nom}}$  und die zulässigen Minimal- und Maximalwerte bei  $L_x = 55,1 \text{ mm}$ :

$$R = 172 \text{ N/mm} \pm 10\% \quad L_0 = 76 \text{ mm} \pm 1\%$$

$$R_{\text{min}} = 154,8 \text{ N/mm} \quad L_{0 \text{ min}} = 75,24 \text{ mm}$$

$$R_{\text{max}} = 189,2 \text{ N/mm} \quad L_{0 \text{ max}} = 76,76 \text{ mm}$$

$$F_{x \text{ nom}} = R * (L_0 - L_x)$$

$$F_{x \text{ nom}} = 172,0 \text{ N/mm} * (76,0 - 55,1) \text{ mm}$$

$$F_{x \text{ nom}} = 3.595 \text{ N}$$

$$F_{x \text{ min}} = R_{\text{min}} * (L_{0 \text{ min}} - L_x)$$

$$F_{x \text{ min}} = 154,8 \text{ N/mm} * (75,24 - 55,1) \text{ mm}$$

$$F_{x \text{ min}} = 3.117,67 \text{ N}$$

$$F_{x \text{ max}} = R_{\text{max}} * (L_{0 \text{ max}} - L_x)$$

$$F_{x \text{ max}} = 189,2 \text{ N/mm} * (76,76 - 55,1) \text{ mm}$$

$$F_{x \text{ max}} = 4.098,07 \text{ N}$$

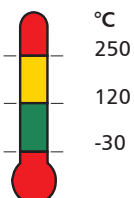

Im Temperaturbereich von 120 bis 250 °C ist je 40 °C mit einem Verlust der Federrate von 1 - 2 % zu rechnen.

## Systemfedernbeschichtung KTL Kathodische Tauchlackierung

Die Gasdruckfedern der Serien NV 5 1S bis NV 5 5S sind mittels besonders strapazierfähiger kathodischer Tauchlackierung beschichtet.

### Verfahren:

Zuerst wird das Werkstück gereinigt. Das negativ geladene, zu beschichtende Werkstück wird in ein Lackbad mit positiv geladenen Lackpartikeln getaucht. Diese Partikel werden vom Werkstück angezogen, auf ihm abgeschieden und bilden dort einen ebenmäßigen Film über die gesamte Oberfläche bis zum Erreichen der vorgegebenen Schichtdicke. Danach werden überschüssige Reste des Tauchlacks in einer Spülzone entfernt. Im Anschluss erfolgt eine Wärmebehandlung (Einbrennen) bei 180 bis 220 °C.

### Vorzüge:

- guter Korrosionsschutz
- hohe Schlagfestigkeit
- exzellente Kratzfestigkeit
- beständig gegen Lösemittel, Säuren und Laugen
- gleichmäßige Schichtdicke
- sehr umweltfreundliches Verfahren (Lösemittel wasserbasiert)

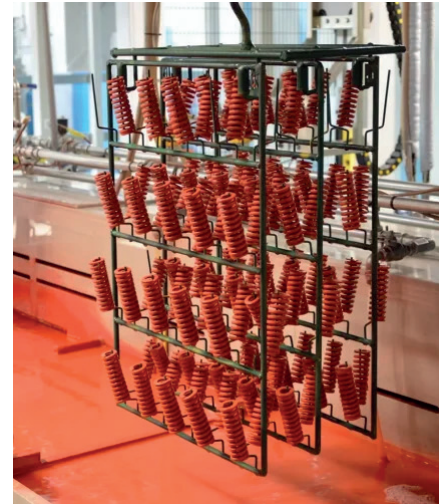

# Einbaurichtlinien für Systemfedern

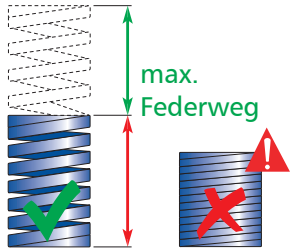

Systemfedern nicht über dem maximalen Federweg (Lebensdauerstufe D) einsetzen. Die Lebensdauerstufe E (Block) sollte vermieden werden da sie zu Federbruch und zu Schäden am Werkzeug führen kann. Keine Lagerung der Federn im komprimierten Zustand.

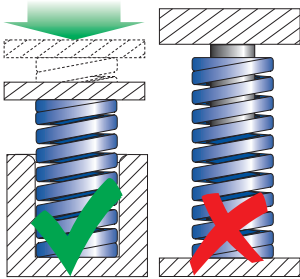

Bei gleichem Gesamtfederweg gilt, dass die Lebensdauer der Federn umso höher ist, je größer die Vorspannung. Federn mit einer größeren Länge bei gleicher Gesamtkraft ermöglichen eine längere Lebensdauer. Es wird eine Vorspannung von mind. 5% empfohlen, da Eigenschwingungen die Lebensdauer der ungespannten Feder minimieren können.

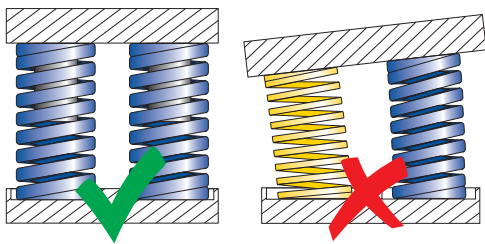

Beim Einsatz mehrerer Federn sollten Federweg und Kräfte ausgeglichen sein. Federn sollten senkrecht zur Auflagefläche verbaut werden.

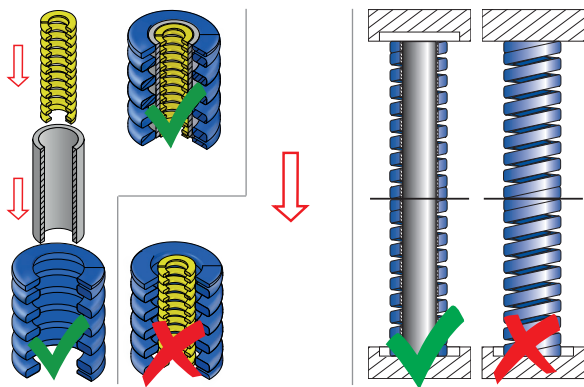

Wenn Systemfedern zur Krafterhöhung ineinander gesteckt werden, dann sollten sie räumlich durch eine Zwischenhülse voneinander getrennt werden.

Wenn Systemfedern zur Hubwegverlängerung übereinander gestapelt werden, dann sollten sie durch einen Dorn geführt werden.

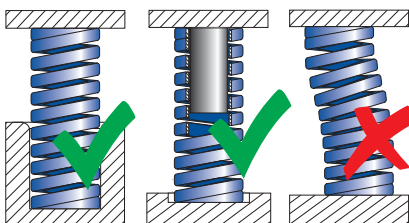

Systemfedern stets mit Außenführung D (Hülse) und / oder Innenführung d (Dorn) einbauen, vor allem wenn  $L_0 / D > 3$ . Je größer die Führung, desto länger ist die Lebensdauer der Feder. Federn sollten mit einem  $L_0 / D$  Verhältnis von mindestens 3,5 geführt werden. Die Einsenktiefe bzw. Dornlänge sollte mindestens zwei bis drei Federwindungen betragen.

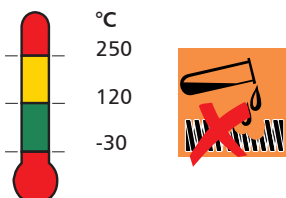

Systemfedern können bei Temperaturen von -30 °C bis +250 °C eingesetzt werden. Im Temperaturbereich von 120 bis 250 °C ist je 40 °C mit einem Verlust der Federrate von 1 - 2 % zu rechnen.

Schützen Sie die Federn vor korrosiven Stoffen. Rostige Federn stets ersetzen.

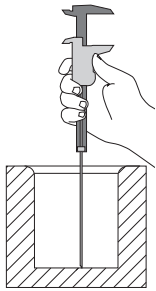

Wartungseingriffe an der Aufnahmebohrung können den Federweg beeinflussen. Federwege sollten stets kontrolliert und Wartungseingriffe vermieden werden.

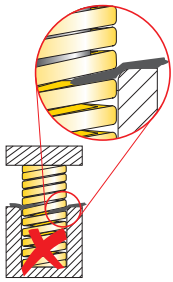

Fremdkörper zwischen den Windungen der Feder können zu einer Wegreduzierung und damit zu Überlastung und Federbruch führen. Fremdkörper sollten stets entfernt werden.

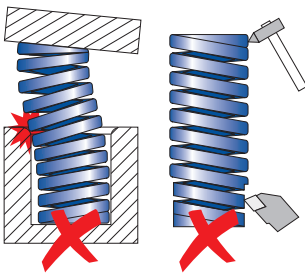

Schäden auf der Oberfläche der Federn (Schnitte, Abschürfungen, Abrieb) können die Lebensdauer deutlich reduzieren. Beschädigte Federn sollten gewechselt werden.

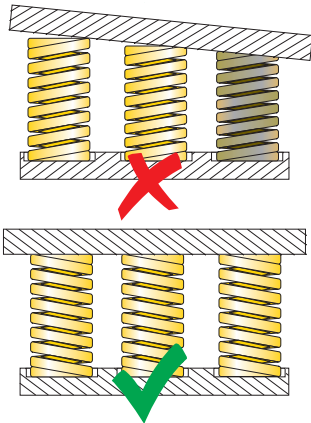

Durch eine beschädigte Feder entsteht ein Spannungsgleichgewicht, durch das andere Federn beschädigt werden könnten. Beschädigte Federn sollten stets ausgewechselt werden. Ein geplantes Auswechseln der Federn beugt Schäden vor.

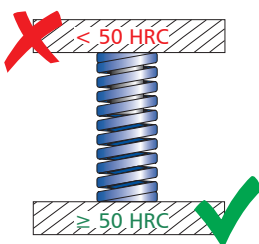

Die Federn sind aus gehärtetem Stahl gefertigt. Um Verschleiß und Abrieb an der Oberfläche zu verhindern wird empfohlen, Materialien mit mind. 50 HRC einzusetzen.

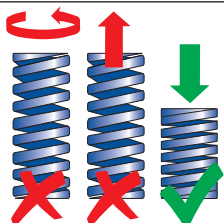

Keine Kräfte entgegen der Kompressionsrichtung der Feder anwenden. Federn niemals ziehen oder verdrehen.

# NV 5 1L

## Systemfedern 1L für extra leichte Last

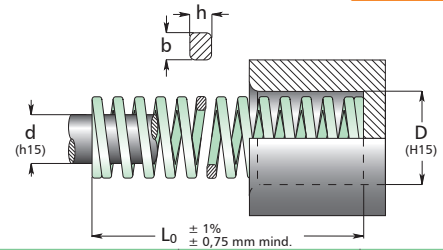

Bestell-Nr.	D		L <sub>0</sub>	R ±10%	A		B		C		D		E
	ø mm	ø mm			s	F	s	F	s	F	s	F	
NV5 1L10025	10	5	25	8,5	7,5	63,8	10,0	85,0	11,3	96,1	12,5	106,3	14,1
NV5 1L10032			32	6,5	9,6	62,4	12,8	83,2	14,4	93,6	16,0	104,0	18,5
NV5 1L10038			38	5,5	11,4	62,7	15,2	83,6	17,7	94,1	19,0	104,5	22,5
NV5 1L10045			44	4,8	13,2	63,4	17,6	84,5	19,8	95,0	22,0	105,6	23,2
NV5 1L10050			51	4,2	15,3	64,3	20,4	85,7	23,0	96,6	25,5	107,1	27,5
NV5 1L10065			64	3,3	19,2	63,4	25,6	84,5	28,8	95,0	32,0	105,6	34,0
NV5 1L10075			76	2,7	22,8	61,6	30,4	82,1	34,2	92,3	38,0	102,6	40,4
NV5 1L10303			305	0,7	91,5	59,5	122,0	79,3	137,3	89,2	152,5	99,1	172,7
NV5 1L13025	12,5	6,3	25	16,0	7,5	120,0	10,0	160,0	11,3	180,8	12,5	200,0	13,6
NV5 1L13032			32	12,2	9,6	117,1	12,8	156,2	14,4	175,7	16,0	195,2	17,9
NV5 1L13038			38	10,3	11,4	117,4	15,2	156,6	17,1	176,1	19,0	195,7	21,9
NV5 1L13045			44	8,7	13,2	114,8	17,6	153,1	19,8	172,3	22,0	191,4	26,4
NV5 1L13050			51	7,5	15,3	114,8	20,4	153,0	23,0	172,5	25,5	191,3	29,6
NV5 1L13065			64	5,8	19,2	11,4	25,6	148,5	28,8	167,0	32,0	185,6	37,1
NV5 1L13075			76	4,7	22,8	107,2	30,4	142,9	34,2	160,7	38,0	178,6	44,9
NV5 1L13090			89	4,1	26,7	109,5	35,6	146,0	40,1	164,4	44,5	182,5	53,2
NV5 1L13101	102	3,6	30,6	11,02	40,8	146,9	45,9	165,2	51,0	183,6	59,4		
NV5 1L13303	305	1,3	91,5	114,4	122,0	152,5	137,3	171,6	152,5	190,6	186,6		
NV5 1L16025	16	8	25	20,2	7,5	151,5	10,0	202,0	11,3	228,3	12,5	252,5	14,0
NV5 1L16032			32	16,0	9,6	153,6	12,8	204,8	14,4	230,4	16,0	256,0	18,7
NV5 1L16038			38	12,3	11,4	140,2	15,2	187,0	17,1	210,3	9,0	233,7	22,0
NV5 1L16045			44	10,6	13,2	139,9	17,6	186,6	19,8	209,9	22,0	233,2	26,1
NV5 1L16050			51	8,9	15,3	136,2	20,4	181,6	23,0	204,7	25,5	227,0	30,4
NV5 1L16065			64	7,0	19,2	134,4	25,6	179,2	28,8	201,6	32,0	224,0	38,8
NV5 1L16075			76	5,8	22,8	132,2	30,4	176,3	34,2	198,4	38,0	220,4	46,4
NV5 1L16090			89	4,8	26,7	128,2	35,6	170,9	40,1	192,5	44,5	213,6	54,2
NV5 1L16101	102	4,1	30,6	125,5	40,8	167,3	45,9	188,2	51,0	209,1	62,4		
NV5 1L16115	115	3,9	34,5	134,6	46,0	179,4	51,8	202,0	57,5	224,3	70,6		
NV5 1L16303	305	1,5	91,5	137,3	122,0	183,0	137,3	206,0	152,5	228,8	190,2		
NV5 1L19025	20	10	25	29,4	7,5	220,5	10,0	294,0	11,3	332,2	12,5	267,5	13,9
NV5 1L19032			32	22,6	9,6	217,0	12,8	289,3	14,4	325,4	16,0	361,6	18,2
NV5 1L19038			38	18,6	11,4	212,0	15,2	282,7	17,1	318,1	19,0	353,4	22,0
NV5 1L19045			44	15,7	13,2	207,2	17,6	276,3	19,8	310,9	22,0	345,4	25,8
NV5 1L19050			51	13,7	15,3	209,6	20,4	279,5	23,0	315,1	25,5	349,4	30,3
NV5 1L19065			64	11,3	19,2	217,0	25,6	289,3	28,8	325,4	32,0	361,6	38,9
NV5 1L19075			76	9,8	22,8	223,4	30,4	297,9	34,2	335,2	38,0	372,4	47,0
NV5 1L19090			89	8,3	26,7	221,6	35,6	295,5	40,1	332,8	44,5	369,4	55,7
NV5 1L19101	102	7,4	30,6	226,4	40,8	301,9	45,9	339,7	51,0	377,4	64,2		
NV5 1L19115	115	6,4	34,5	220,8	46,0	294,4	51,8	331,5	57,5	368,0	72,9		
NV5 1L19126	127	5,9	38,1	224,8	50,8	299,7	57,2	337,5	63,5	374,7	80,7		
NV5 1L19140	139	5,4	41,7	225,2	55,6	300,2	62,6	338,0	69,5	375,3	88,4		
NV5 1L19151	152	4,9	45,6	223,4	60,8	297,9	68,4	335,2	76,0	372,4	96,7		
NV5 1L19303	305	2,5	91,5	228,8	122,0	305,0	137,3	343,3	152,5	381,3	196,0		
NV5 1L26025	25	12,5	25	53,9	7,5	404,3	10,0	539,0	11,3	609,1	12,5	673,8	12,9
NV5 1L26032			32	42,2	9,6	405,1	12,8	540,2	14,4	607,7	16,0	675,2	17,2
NV5 1L26038			38	35,8	11,4	408,1	15,2	544,2	17,1	612,2	19,0	680,2	20,7
NV5 1L26045			44	31,4	13,2	414,5	17,6	552,6	19,8	621,7	22,0	690,8	24,4
NV5 1L26050			51	27,0	15,3	413,1	20,4	550,8	23,0	621,7	25,5	688,5	28,5
NV5 1L26065			64	21,6	19,2	414,7	25,6	553,0	28,8	622,1	32,0	691,2	36,5
NV5 1L26075			76	18,1	22,8	412,7	30,4	550,2	34,2	619,0	38,0	687,8	43,9
NV5 1L26090			89	15,2	26,7	405,8	35,6	541,1	40,1	609,5	44,5	676,4	51,4
NV5 1L26101	102	13,2	30,6	403,9	40,8	538,6	45,9	605,9	51,0	673,2	59,3		
NV5 1L26115	115	11,8	34,5	407,1	46,0	542,8	51,8	611,2	57,5	678,5	67,2		
NV5 1L26126	127	10,6	38,1	403,9	50,8	538,5	57,2	606,3	63,5	673,1	74,4		
NV5 1L26140	139	9,6	41,7	400,3	55,6	533,8	62,6	601,0	69,5	667,2	81,6		
NV5 1L26151	152	8,8	45,6	401,3	60,8	535,0	68,4	601,9	76,0	668,8	89,5		
NV5 1L26176	178	7,6	53,4	405,8	71,2	541,1	80,1	608,8	89,0	676,4	105,0		
NV5 1L26202	203	6,7	60,9	408,0	81,2	544,0	91,4	612,4	101,5	680,1	121,0		
NV5 1L26303	305	4,4	91,5	402,6	122,0	536,8	137,3	604,1	152,5	671,0	182,0		

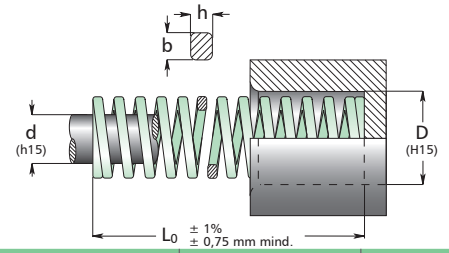

Bestell-Nr.	D	d	L <sub>0</sub>	R ±10%	A 30 % L <sub>0</sub>		B 40 % L <sub>0</sub>		C 45 % L <sub>0</sub>		D 50 % L <sub>0</sub>		E ⚠		
	ø mm	ø mm			s mm	F N	s mm	F N	s mm	F N	s mm	F N		s mm	F N
NV 5 1L32038	32	16	38	43,1	11,4	491,3	15,2	655,1	17,1	737,0	19,0	818,9	19,9		
NV 5 1L32045			44	37,3	13,2	492,4	17,6	656,5	19,8	738,5	22,0	820,6	23,5		
NV 5 1L32050			51	32,4	15,3	495,7	20,4	661,0	23,0	745,2	25,5	826,2	27,6		
NV 5 1L32065			64	25,5	19,2	489,6	25,6	652,8	28,8	734,4	32,0	816,0	35,2		
NV 5 1L32075			76	21,6	22,8	492,5	30,4	656,6	34,2	738,7	38,0	820,8	42,4		
NV 5 1L32090			89	18,1	26,7	483,3	35,6	644,4	40,1	725,8	44,5	805,5	50,0		
NV 5 1L32101			102	15,7	30,6	480,4	40,8	640,6	45,9	720,6	51,0	800,7	57,6		
NV 5 1L32115			6,5 x 2,6	115	14,2	34,5	489,9	46,0	653,2	51,8	735,6	57,5	816,5	65,5	
NV 5 1L32126				127	12,7	38,1	483,9	50,8	645,2	57,2	726,4	63,5	806,5	72,5	
NV 5 1L32140				139	11,6	41,7	483,7	55,6	645,0	62,6	726,2	69,5	806,2	79,4	
NV 5 1L32151				152	10,6	45,6	483,4	60,8	644,5	68,4	725,0	76,0	805,6	87,3	
NV 5 1L32176				178	9,0	53,4	480,6	71,2	640,8	80,1	720,9	89,0	801,0	103,0	
NV 5 1L32202				203	7,8	60,9	475,0	81,2	633,4	91,4	712,9	101,5	791,7	118,0	
NV 5 1L32252				254	6,4	76,2	487,7	101,6	650,2	114,3	731,5	127,0	812,8	148,0	
NV 5 1L32303	305	5,3	91,5	485,0	122,0	646,6	137,3	727,7	152,5	803,3	178,0				
NV 5 1L38050	40	20	51	48,1	15,3	736,0	20,4	981,0	23,0	1.106,0	25,5	1.227,0	28,0		
NV 5 1L38065			64	39,2	19,2	753,0	25,6	1.004,0	28,8	1.129,0	32,0	1.254,0	36,2		
NV 5 1L38075			76	33,3	22,8	759,0	30,4	1.012,0	34,2	1.139,0	38,0	1.265,0	43,7		
NV 5 1L38090			89	28,4	26,7	758,0	35,6	1.011,0	40,1	1.139,0	44,5	1.264,0	51,7		
NV 5 1L38101			102	24,5	30,6	750,0	40,8	1.000,0	45,9	1.125,0	51,0	1.250,0	59,8		
NV 5 1L38115			115	22,1	34,5	762,0	46,0	1.017,0	51,8	1.145,0	57,5	1.271,0	67,9		
NV 5 1L38126			8,0 x 3,4	127	19,6	38,1	747,0	50,8	996,0	57,2	1.121,0	63,5	1.245,0	75,2	
NV 5 1L38140				139	17,7	41,7	738,0	55,6	984,0	62,6	1.108,0	69,5	1.230,0	82,4	
NV 5 1L38151				152	16,2	45,6	739,0	60,8	985,0	68,4	1.108,0	76,0	1.231,0	90,6	
NV 5 1L38176				178	13,7	53,4	732,0	71,2	975,0	80,1	1.097,0	89,0	1.219,0	106,0	
NV 5 1L38202				203	12,3	60,9	749,0	81,2	999,0	91,4	1.124,0	101,5	1.248,0	122,0	
NV 5 1L38252				254	9,8	76,2	747,0	101,6	996,0	114,3	1.120,0	127,0	1.245,0	154,0	
NV 5 1L38303				305	8,3	91,5	759,0	122,0	1.013,0	137,3	1.140,0	152,5	1.266,0	185,0	
NV 5 1L51065			50	25	64	86,3	19,2	1.657,0	25,6	2.209,0	28,8	2.485,0	32,0	2.762,0	35,1
NV 5 1L51075	76	70,6			22,8	1.610,0	30,4	2.146,0	34,2	2.415,0	38,0	2.683,0	42,2		
NV 5 1L51090	89	59,8			26,7	1.597,0	35,6	2.129,0	40,1	2.398,0	44,5	2.661,0	50,3		
NV 5 1L51101	102	52,0			30,6	1.591,0	40,8	2.122,0	45,9	2.387,0	51,0	2.652,0	58,4		
NV 5 1L51115	115	46,1			34,5	1.590,0	46,0	2.121,0	51,8	2.388,0	57,5	2.651,0	66,1		
NV 5 1L51126	10,5 x 4,1	127			42,2	38,1	1.608,0	50,8	2.144,0	57,2	2.414,0	63,5	2.680,0	73,8	
NV 5 1L51140		139			38,3	41,7	1.593,0	55,6	2.124,0	62,6	2.391,0	69,5	2.655,0	80,9	
NV 5 1L51151		152			34,3	45,6	1.564,0	60,8	2.085,0	68,4	2.346,0	76,0	2.607,0	89,0	
NV 5 1L51176		178			29,4	53,4	1.570,0	71,2	2.093,0	80,1	2.355,0	89,0	2.617,0	105,0	
NV 5 1L51202		203			25,5	60,9	1.553,0	81,2	2.071,0	91,4	2.331,0	101,5	2.588,0	121,0	
NV 5 1L51252		254			20,6	76,2	1.570,0	101,6	2.093,0	114,3	2.355,0	127,0	2.616,0	152,0	
NV 5 1L51303		305			17,2	91,5	1.574,0	122,0	2.098,0	137,3	2.362,0	152,5	2.623,0	184,0	
NV 5 1L63075	63	38			76	57,8	22,8	1.318,0	30,4	1.757,0	34,2	1.977,0	38,0	2.196,0	47,3
NV 5 1L63090					89	51,4	26,7	1.372,0	35,6	1.830,0	40,1	2.061,0	44,5	2.287,0	54,9
NV 5 1L63101			102	44,4	30,6	1.359,0	40,8	1.812,0	45,9	2.038,0	51,0	2.264,0	64,1		
NV 5 1L63115			115	38,0	34,5	1.311,0	46,0	1.748,0	51,8	1.968,0	57,5	2.185,0	75,6		
NV 5 1L63126			127	33,2	38,1	1.265,0	50,8	1.687,0	57,2	1.899,0	63,5	2.108,0	82,6		
NV 5 1L63151			152	27,4	45,6	1.249,0	60,8	1.666,0	68,4	1.874,0	76,0	2.082,0	99,8		
NV 5 1L63176			11,0 x 4,9	178	24,0	53,4	1.282,0	71,2	1.709,0	80,1	1.922,0	89,0	2.136,0	118,4	
NV 5 1L63202				203	21,0	60,9	1.279,0	81,2	1.705,0	91,4	1.919,0	101,5	2.132,0	135,9	
NV 5 1L63252				254	16,4	76,2	1.250,0	101,6	1.666,0	114,3	1.875,0	127,0	2.083,0	172,8	
NV 5 1L63303				305	13,6	91,5	1.244,0	122,0	1.659,0	137,3	1.867,0	152,5	2.074,0	208,6	
NV 5 1L63315				315	11,5	94,5	1.086,8	126,0	1.449,0	141,75	1.630,1	157,5	1.811,3	205,0	
NV 5 1L63350				350	9,8	105,0	1.029,0	140,0	1.372,0	157,5	1.543,5	175,0	1.715,0	230,0	
NV 5 1L63400				400	8,0	120,0	960,0	160,0	1.280,0	180,0	1.440,0	200,0	1.600,0	240,0	

NV 5 1S ISO 10243

Systemfedern für leichte Last

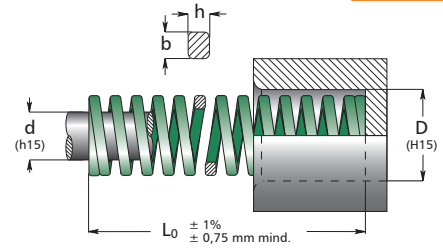

Bestell-Nr.	D		L <sub>0</sub>	R ±10%	A 25 % L <sub>0</sub>		B 30 % L <sub>0</sub>		C 35 % L <sub>0</sub>		D 40 % L <sub>0</sub>		E ⚠
	ø mm	ø mm			s mm	F N	s mm	F N	s mm	F N	s mm	F N	
NV 5 1S10025	10	5 	25	11,0	6,3	69,3	7,5	82,5	8,8	96,8	10,0	110,0	13,5
NV 5 1S10032			32	8,5	8,0	68,0	9,6	81,6	11,2	95,2	12,8	108,8	17,5
NV 5 1S10038			38	6,8	9,5	64,6	11,4	77,5	13,3	90,4	15,2	103,4	20,8
NV 5 1S10045			44	6,0	11,0	66,0	13,2	79,2	15,4	92,4	17,6	105,6	23,9
NV 5 1S10050			51	5,0	12,8	64,0	15,3	76,5	17,9	89,5	20,4	102,0	28,9
NV 5 1S10065			64	4,1	16,0	65,5	19,2	78,7	22,4	91,8	25,6	105,0	36,1
NV 5 1S10075			76	3,6	19,0	68,4	22,8	82,1	26,6	95,8	30,4	109,4	43,2
NV 5 1S10303			305	0,9	76,3	68,7	91,5	82,4	106,8	96,1	122,0	109,8	178,0
NV 5 1S13025	12,5	6,3 	25	21,0	6,3	132,3	7,5	157,5	8,8	184,8	10,0	210,0	13,2
NV 5 1S13032			32	16,4	8,0	131,2	9,6	157,4	11,2	183,7	12,8	209,9	18,0
NV 5 1S13038			38	13,6	9,5	129,2	11,4	155,0	13,3	180,9	15,2	206,7	21,0
NV 5 1S13045			44	12,1	11,0	133,1	13,2	159,7	15,4	186,3	17,6	213,0	24,0
NV 5 1S13050			51	10,3	12,8	131,8	15,3	157,6	17,9	184,4	20,4	210,1	28,7
NV 5 1S13065			64	7,6	16,0	121,6	19,2	145,9	22,4	170,2	25,6	194,6	35,8
NV 5 1S13075			76	6,3	19,0	119,7	22,8	143,6	26,6	167,6	30,4	191,5	42,7
NV 5 1S13090			89	5,4	22,3	120,4	26,7	144,2	31,2	168,5	35,6	192,2	50,4
NV 5 1S13101	102	4,1	25,5	104,6	30,6	125,5	35,7	146,4	40,8	167,3	58,4		
NV 5 1S13303	305	1,6	76,3	122,1	91,5	146,4	106,8	170,9	122,0	195,2	172,0		
NV 5 1S16025	16	8 	25	29,0	6,3	182,7	7,5	217,5	8,8	255,2	10,0	290,0	12,6
NV 5 1S16032			32	22,9	8,0	183,2	9,6	219,8	11,2	265,5	12,8	293,1	16,4
NV 5 1S16038			38	19,3	9,5	183,4	11,4	220,0	13,3	256,7	15,2	293,4	19,7
NV 5 1S16045			44	17,1	11,0	188,1	13,2	225,7	15,4	263,3	17,6	301,0	22,5
NV 5 1S16050			51	14,0	12,8	179,2	15,3	214,2	17,9	250,6	20,4	285,6	26,3
NV 5 1S16065			64	10,7	16,0	171,2	19,2	205,4	22,4	239,7	25,6	273,9	33,3
NV 5 1S16075			76	9,0	19,0	171,0	22,8	205,2	26,6	239,4	30,4	273,6	40,2
NV 5 1S16090			89	7,3	22,3	162,8	26,7	194,9	31,2	227,8	35,6	259,9	47,6
NV 5 1S16101	102	6,8	25,5	173,4	30,6	208,1	35,7	242,8	40,8	277,4	55,4		
NV 5 1S16115	115	6,6	28,8	190,1	34,5	227,7	40,3	266,0	46,0	303,6	60,8		
NV 5 1S16303	305	2,3	76,3	175,5	91,5	210,5	106,8	245,6	122,0	280,6	165,0		
NV 5 1S19025	20	10 	25	55,8	6,3	351,5	7,5	418,5	8,8	491,0	10,0	558,0	12,1
NV 5 1S19032			32	45,0	8,0	360,0	9,6	432,0	11,2	504,0	12,8	576,0	15,3
NV 5 1S19038			38	36,0	9,5	342,0	11,4	410,4	13,3	478,8	15,2	547,2	18,9
NV 5 1S19045			44	30,0	11,0	330,0	13,2	396,0	15,4	462,0	17,6	528,0	21,5
NV 5 1S19050			51	24,5	12,8	313,6	15,3	374,9	17,9	438,6	20,4	499,8	25,0
NV 5 1S19065			64	19,2	16,0	307,2	19,2	368,6	22,4	430,1	25,6	491,5	31,1
NV 5 1S19075			76	16,0	19,0	304,0	22,8	364,8	26,6	425,6	30,4	486,4	37,3
NV 5 1S19090			89	14,0	22,3	312,2	26,7	373,8	31,2	436,8	35,6	498,4	44,5
NV 5 1S19101	102	12,0	25,5	306,0	30,6	367,2	35,7	428,4	40,8	489,6	51,1		
NV 5 1S19115	115	10,9	28,8	313,9	34,5	376,1	40,3	439,3	46,0	501,4	58,2		
NV 5 1S19126	127	9,5	31,8	302,1	38,1	362,0	44,5	422,8	50,8	482,6	64,9		
NV 5 1S19140	139	8,4	34,8	292,3	41,7	350,3	48,7	409,1	55,6	467,0	71,5		
NV 5 1S19151	152	7,5	38,0	285,0	45,6	342,0	53,2	399,0	60,8	456,0	78,8		
NV 5 1S19176	178	7,1	44,5	316,0	53,4	379,1	62,3	442,3	71,2	505,5	89,0		
NV 5 1S19303	305	4,0	76,3	305,2	91,5	366,0	106,8	427,2	122,0	488,0	157,0		
NV 5 1S26025	25	12,5 	25	105,0	6,3	661,5	7,5	787,5	8,8	924,0	10,0	1.050,0	11,9
NV 5 1S26032			32	80,3	8,0	642,4	9,6	770,9	11,2	899,4	12,8	1.027,8	16,0
NV 5 1S26038			38	62,0	9,5	589,0	11,4	706,8	13,3	824,6	15,2	942,4	18,3
NV 5 1S26045			44	52,9	11,0	581,9	13,2	698,3	15,4	814,7	17,6	931,0	21,4
NV 5 1S26050			51	44,0	12,8	563,2	15,3	673,2	17,9	787,6	20,4	897,6	24,9
NV 5 1S26065			64	35,2	16,0	563,2	19,2	675,8	22,4	788,5	25,6	901,1	31,4
NV 5 1S26075			76	28,0	19,0	532,0	22,8	638,4	26,6	744,8	30,4	851,2	37,5
NV 5 1S26090			89	24,0	22,3	535,2	26,7	640,8	31,2	748,8	35,6	854,4	43,5
NV 5 1S26101	102	21,1	25,5	538,1	30,6	645,7	35,7	753,3	40,8	860,9	51,1		
NV 5 1S26115	115	18,7	28,8	538,6	34,5	645,2	40,3	753,6	46,0	860,2	58,1		
NV 5 1S26126	127	16,7	31,8	531,1	38,1	636,3	44,5	743,2	50,8	848,4	64,1		
NV 5 1S26140	139	15,3	34,8	532,4	41,7	638,0	48,7	745,1	55,6	850,7	70,4		
NV 5 1S26151	152	14,0	38,0	532,0	45,6	638,4	53,2	744,8	60,8	851,2	77,1		
NV 5 1S26176	178	12,5	44,5	556,3	53,4	667,5	62,3	778,8	71,2	890,0	93,1		
NV 5 1S26202	203	10,4	50,8	528,3	60,9	633,4	71,1	739,4	81,2	844,5	103,0		
NV 5 1S26303	305	7,0	76,3	534,1	91,5	640,5	106,8	747,6	122,0	854,0	156,0		

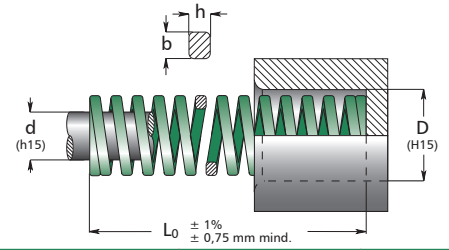

Bestell-Nr.	D	d	L <sub>0</sub>	R	A		B		C		D		E		
	ø mm	ø mm	mm	±10%	s	F	s	F	s	F	s	F	s		
				N/mm	mm	N	mm	N	mm	N	mm	N	mm		
NV 5 1S32038	32	16	38	98,0	9,5	931,0	11,4	1.117	13,3	1.303	15,2	1.490	18,3		
NV 5 1S32045			44	79,5	11,0	875,0	13,2	1.049	15,4	1.224	17,6	1.399	21,5		
NV 5 1S32050			51	67,0	12,8	858,0	15,3	1.025	17,9	1.199	20,4	1.367	25,5		
NV 5 1S32065			64	53,0	16,0	848,0	19,2	1.018	22,4	1.187	25,6	1.357	31,9		
NV 5 1S32075			76	44,0	19,0	836,0	22,8	1.003	26,6	1.170	30,4	1.338	38,6		
NV 5 1S32090			89	37,2	22,3	830,0	26,7	993	31,2	1.161	35,6	1.324	46,5		
NV 5 1S32101			102	32,0	25,5	816,0	30,6	979	35,7	1.142	40,8	1.306	53,2		
NV 5 1S32115			115	29,0	28,8	835,0	34,5	1.001	40,3	1.169	46,0	1.334	60,0		
NV 5 1S32126			127	25,0	31,8	795,0	38,1	953	44,5	1.113	50,8	1.270	66,7		
NV 5 1S32140			139	23,0	34,8	800,0	41,7	959	48,7	1.120	55,6	1.279	71,8		
NV 5 1S32151			152	21,5	38,0	817,0	45,6	980	53,2	1.144	60,8	1.307	78,5		
NV 5 1S32176			178	18,2	44,5	810,0	53,4	972	62,3	1.134	71,2	1.296	94,4		
NV 5 1S32202			203	15,8	50,8	803,0	60,9	962	71,7	1.123	81,2	1.283	107,0		
NV 5 1S32252			254	12,5	63,5	794,0	76,2	953	88,9	1.111	102,0	1.275	136,0		
NV 5 1S32303			305	10,3	76,3	786,0	91,5	942	106,8	1.100	122,0	1.257	163,0		
NV 5 1S38050	40	20	51	92,0	12,8	1.178	15,3	1.408	17,9	1.647	20,4	1.877	25,5		
NV 5 1S38065			64	73,0	16,0	1.168	19,2	1.402	22,4	1.635	25,6	1.869	31,4		
NV 5 1S38075			76	63,0	19,0	1.197	22,8	1.436	26,6	1.676	30,4	1.915	37,8		
NV 5 1S38090			89	51,0	22,3	1.137	26,7	1.362	31,2	1.591	35,6	1.816	44,3		
NV 5 1S38101			102	45,0	25,5	1.148	30,6	1.377	35,7	1.1607	40,8	1.836	50,7		
NV 5 1S38115			115	39,6	28,8	1.140	34,5	1.366	40,3	1.596	46,0	1.822	58,1		
NV 5 1S38126			127	36,0	31,8	1.145	38,1	1.372	44,5	1.602	50,8	1.829	64,6		
NV 5 1S38140			139	32,0	34,8	1.114	41,7	1.334	48,7	1.558	55,6	1.779	70,1		
NV 5 1S38151			152	28,0	38,0	1.064	45,6	1.277	53,2	1.490	60,8	1.702	76,6		
NV 5 1S38176			178	25,2	44,5	1.121	53,4	1.346	62,3	1.570	71,2	1.794	90,4		
NV 5 1S38202			203	21,8	50,8	1.107	60,9	1.328	71,7	1.550	81,2	1.770	102,0		
NV 5 1S38252			254	17,0	63,5	1.080	76,2	1.295	88,9	1.511	102,0	1.734	129,0		
NV 5 1S38303			305	14,8	76,3	1.129	91,5	1.354	106,8	1.581	122,0	1.806	156,0		
NV 5 1S51065			50	25	64	156,0	16,0	2.496	19,2	2.995	22,4	3.494	25,6	3.994	31,0
NV 5 1S51075					76	125,0	19,0	2.375	22,8	2.850	26,6	3.325	30,4	3.800	37,2
NV 5 1S51090	89	109,0			22,3	2.431	26,7	2.910	31,2	3.401	35,6	3.880	43,6		
NV 5 1S51101	102	94,0			25,5	2.397	30,6	2.876	35,7	3.356	40,8	3.835	50,3		
NV 5 1S51115	115	81,0			28,8	2.333	34,5	2.795	40,3	3.264	46,0	3.726	58,1		
NV 5 1S51126	127	71,0			31,8	2.258	38,1	2.705	44,5	3.160	50,8	3.607	63,7		
NV 5 1S51140	139	66,5			34,8	2.314	41,7	2.773	48,7	3.239	55,6	3.697	69,5		
NV 5 1S51151	152	60,0			38,0	2.280	45,6	2.736	53,2	3.192	60,8	3.648	76,5		
NV 5 1S51176	178	52,0			44,5	2.314	53,4	2.777	62,3	3.240	71,2	3.702	91,9		
NV 5 1S51202	203	44,0			50,8	2.235	60,9	2.680	71,1	3.128	81,2	3.573	105,0		
NV 5 1S51252	254	35,0			63,5	2.223	76,2	2.667	88,9	3.112	102,0	3.570	131,0		
NV 5 1S51303	305	28,5			76,3	2.175	91,5	2.608	106,8	3.044	122,0	3.477	155,0		
NV 5 1S63075	63	38			76	189,0	19,0	3.591	22,8	4.309	26,6	5.027	30,4	5.746	36,5
NV 5 1S63090					89	158,0	22,3	3.523	26,7	4.219	31,2	4.930	35,6	5.625	43,4
NV 5 1S63101					102	131,0	25,5	3.341	30,6	4.009	35,7	4.677	40,8	5.345	49,7
NV 5 1S63115			115	116,0	28,8	3.341	34,5	4.002	40,3	4.675	46,0	5.336	55,6		
NV 5 1S63126			127	103,0	31,8	3.275	38,1	3.924	44,5	4.584	50,8	5.232	62,7		
NV 5 1S63151			152	84,3	38,0	3.203	45,6	3.844	53,2	4.485	60,8	5.125	77,1		
NV 5 1S63176			178	71,5	44,5	3.182	53,4	3.818	62,3	4.454	71,2	5.091	92,2		
NV 5 1S63202			203	61,7	50,8	3.134	60,9	3.758	71,1	4.387	81,2	5.010	103,0		
NV 5 1S63252			254	47,0	63,5	2.985	76,2	3.581	88,9	4.178	102,0	4.794	130,0		
NV 5 1S63303			305	38,2	76,3	2.915	91,5	3.495	106,8	4.080	122,0	4.660	157,0		
NV 5 1S63315			315	38,0	78,75	2.992,5	94,5	3.591	110,25	4.189,5	126,0	4.788	140,0		
NV 5 1S63350			350	34,0	87,5	2.975	105,0	3.570	122,5	4.165	140,0	4.760	165,0		
NV 5 1S63400			400	28,8	100,0	2.880	120,0	3.456	140,0	4.032	160,0	4.608	185,0		

kursiv: keine ISO Norm

NV 5 2S ISO 10243

Systemfedern für mittlere Last

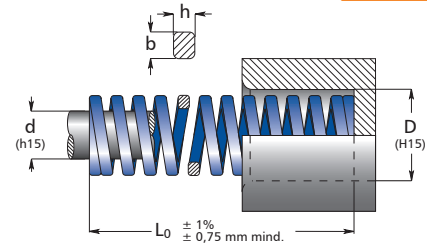

Bestell-Nr.	D		L <sub>0</sub>	R ±10%	A 25 % L <sub>0</sub>		B 30 % L <sub>0</sub>		C 33,75 % L <sub>0</sub>		D 37,5 % L <sub>0</sub>		E
	ø mm	ø mm			s mm	F N	s mm	F N	s mm	F N	s mm	F N	
NV5 2S10025	10	5	25	16,0	6,3	100,8	7,5	120,0	8,4	134,4	9,4	150,4	10,2
NV5 2S10032			32	13,0	8,0	104,0	9,6	124,8	10,8	140,4	12,0	156,0	14,2
NV5 2S10038			38	11,9	9,5	113,1	11,4	135,7	12,8	152,3	14,2	169,0	16,8
NV5 2S10045			44	10,3	11,0	113,3	13,2	136,0	14,9	153,5	16,5	170,0	19,4
NV5 2S10050			51	8,9	12,8	113,9	15,3	136,2	17,2	153,1	19,1	170,0	23,4
NV5 2S10065			64	7,5	16,0	120,0	19,2	144,0	21,6	162,0	24,0	180,0	28,2
NV5 2S10075			76	5,3	19,0	117,8	22,8	141,4	25,7	159,3	28,5	176,7	34,2
NV5 2S10102			102	4,4	25,5	112,0	30,6	134,6	34,4	151,4	38,3	168,5	44,0
NV5 2S10303			305	1,6	76,3	122,1	91,5	146,4	102,9	164,6	114,0	182,4	134,0
NV5 2S13025			12,5	6,3	25	30,0	6,3	189,0	7,5	225,0	8,4	252,0	9,4
NV5 2S13032	32	24,8			8,0	198,4	9,6	238,1	10,8	267,8	12,0	297,6	16,2
NV5 2S13038	38	21,4			9,5	203,3	11,4	244,0	12,8	273,9	14,2	303,9	18,7
NV5 2S13045	44	18,0			11,0	198,0	13,2	237,6	14,9	268,2	16,5	297,0	21,3
NV5 2S13050	51	15,5			12,8	198,4	15,3	237,2	17,2	266,6	19,1	296,1	25,6
NV5 2S13065	64	12,1			16,0	193,6	19,2	232,3	21,6	261,4	24,0	290,4	32,4
NV5 2S13075	76	10,2			19,0	193,8	22,8	232,6	25,7	262,1	28,5	290,7	39,0
NV5 2S13090	89	8,4			22,3	187,3	26,7	224,3	30,0	252,0	33,3	279,7	45,9
NV5 2S13101	102	6,3			25,5	160,7	30,6	192,8	34,4	216,7	38,3	241,0	52,3
NV5 2S13303	305	2,4			76,3	183,1	91,5	219,6	102,9	247,0	114,0	273,6	153,0
NV5 2S16025	16	8	25	49,4	6,3	311,2	7,5	370,5	8,4	415,0	9,4	464,4	10,5
NV5 2S16032			32	38,5	8,0	308,0	9,6	369,6	10,8	415,8	12,0	462,0	13,2
NV5 2S16038			38	33,9	9,5	322,1	11,4	386,5	12,8	433,9	14,2	481,4	17,2
NV5 2S16045			44	30,0	11,0	330,0	13,2	396,0	14,9	447,0	16,5	495,0	19,4
NV5 2S16050			51	26,4	12,8	337,9	15,3	403,9	17,2	454,1	19,1	504,2	24,2
NV5 2S16065			64	20,5	16,0	328,0	19,2	393,6	21,6	442,8	24,0	492,0	29,2
NV5 2S16075			76	17,8	19,0	338,2	22,8	405,8	25,7	457,5	28,5	507,3	36,3
NV5 2S16090			89	15,2	22,3	339,0	26,7	405,8	30,0	456,0	33,3	506,2	41,7
NV5 2S16101			102	13,5	25,5	344,3	30,6	413,1	34,4	464,4	38,2	515,7	48,9
NV5 2S16115			115	11,8	28,8	339,8	34,5	407,1	38,8	457,8	43,1	508,6	53,1
NV5 2S16303	305	4,3	76,3	328,1	91,5	439,5	102,9	442,5	114,0	590,2	142,0		
NV5 2S19025	20	10	25	98,0	6,3	617,4	7,5	735,0	8,4	823,2	9,4	921,2	10,5
NV5 2S19032			32	72,6	8,0	580,8	9,6	697,0	10,8	784,1	12,0	871,2	13,9
NV5 2S19038			38	56,0	9,5	532,0	11,4	638,4	12,8	716,8	14,2	795,2	16,6
NV5 2S19045			44	47,5	11,0	522,0	13,2	627,0	14,9	707,8	16,5	783,8	18,8
NV5 2S19050			51	41,7	12,8	533,8	15,3	638,0	17,2	717,2	19,1	796,5	23,1
NV5 2S19065			64	32,2	16,0	516,8	19,2	620,2	21,6	697,7	24,0	775,2	27,5
NV5 2S19075			76	25,1	19,0	476,9	22,8	572,3	25,7	645,1	28,5	715,4	33,8
NV5 2S19090			89	22,0	22,3	490,6	26,7	587,4	30,0	660,0	33,3	732,6	39,7
NV5 2S19101			102	19,8	25,5	504,9	30,6	605,9	34,4	681,1	38,2	756,4	47,3
NV5 2S19115			115	18,1	28,8	521,3	34,5	624,5	38,8	702,3	43,1	780,1	52,5
NV5 2S19126	127	16,6	31,8	527,9	38,1	632,5	42,9	712,1	47,6	790,2	56,9		
NV5 2S19140	139	15,1	34,8	525,5	42,0	629,7	46,9	708,2	52,1	786,7	62,1		
NV5 2S19151	152	13,2	38,0	501,6	45,6	601,9	51,3	677,2	57,0	752,4	67,6		
NV5 2S19303	305	6,1	76,3	465,4	91,5	558,2	102,9	627,7	114,0	695,4	143,0		
NV5 2S26025	25	12,5	25	157,0	6,3	989,0	7,5	1.178,0	8,4	1.319,0	9,4	1.476,0	10,2
NV5 2S26032			32	118,0	8,0	944,0	9,6	1.133,0	10,8	1.274,0	12,0	1.416,0	13,7
NV5 2S26038			38	93,0	9,5	884,0	11,4	1.060,0	12,8	1.190,0	14,2	1.321,0	15,7
NV5 2S26045			44	80,8	11,0	889,0	13,2	1.067,0	14,9	1.204,0	16,5	1.333,0	18,2
NV5 2S26050			51	68,6	12,8	878,0	15,3	1.050,0	17,2	1.180,0	19,1	1.310,0	21,7
NV5 2S26065			64	53,0	16,0	848,0	19,2	1.018,0	21,6	1.145,0	24,0	1.272,0	26,0
NV5 2S26075			76	43,2	19,0	821,0	22,8	985,0	25,7	1.110,0	28,5	1.231,0	32,3
NV5 2S26090			89	38,2	22,3	852,0	26,7	1.020,0	30,0	1.146,0	33,3	1.272,0	38,0
NV5 2S26101			102	33,0	25,5	842,0	30,6	1.010,0	34,4	1.135,0	38,2	1.261,0	43,0
NV5 2S26115			115	28,0	28,8	806,0	34,5	966,0	38,8	1.086,0	43,1	1.207,0	48,6
NV5 2S26126	127	25,9	31,8	824,0	38,1	987,0	42,9	1.111,0	47,6	1.233,0	53,7		
NV5 2S26140	139	23,2	34,8	807,0	42,0	967,0	46,9	1.088,0	52,1	1.209,0	59,4		
NV5 2S26151	152	20,8	38,0	790,0	45,6	948,0	51,3	1.067,0	57,0	1.186,0	63,8		
NV5 2S26176	178	17,8	44,5	792,0	53,4	951,0	60,1	1.070,0	66,7	1.187,0	76,6		
NV5 2S26202	203	15,8	50,8	803,0	60,9	962,0	68,5	1.082,0	76,1	1.202,0	88,4		
NV5 2S26303	305	10,2	76,3	778,0	91,5	933,0	102,9	1.050,0	114,0	1.163,0	135,0		

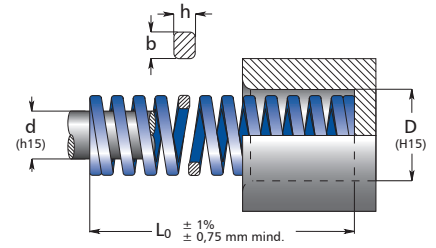

Bestell-Nr.	D	d	L <sub>0</sub>	R	A		B		C		D		E
	ø mm	ø mm	mm	±10%	25 % L <sub>0</sub>		30 % L <sub>0</sub>		33,75 % L <sub>0</sub>		37,5 % L <sub>0</sub>		⚠
				N/mm	s	F	s	F	s	F	s	F	s
			mm		mm	N	mm	N	mm	N	mm	N	mm
NV5 2S32038	32	16	38	185,0	9,5	1.758,0	11,4	2.109,0	12,8	2.368,0	14,2	2.627,0	16,8
NV5 2S32045			44	158,0	11,0	1.738,0	13,2	2.086,0	14,9	2.354,0	16,5	2.607,0	18,9
NV5 2S32050			51	134,0	12,8	1.715,0	15,3	2.050,0	17,2	2.305,0	19,1	2.559,0	23,1
NV5 2S32065			64	99,0	16,0	1.584,0	19,2	1.901,0	21,6	2.138,0	24,0	2.376,0	28,5
NV5 2S32075			76	80,5	19,0	1.530,0	22,8	1.835,0	25,7	2.069,0	28,5	2.294,0	34,2
NV5 2S32090			89	69,1	22,3	1.538,0	26,7	1.845,0	30,3	2.073,0	33,3	2.301,0	40,4
NV5 2S32101			102	58,8	25,5	1.541,0	30,6	1.799,0	34,4	2.023,0	38,2	2.246,0	48,0
NV5 2S32115			115	51,5	28,8	1.499,0	34,5	1.777,0	38,8	1.998,0	43,1	2.220,0	54,3
NV5 2S32126			127	44,8	31,8	1.425,0	38,1	1.707,0	42,9	1.922,0	47,6	2.132,0	59,2
NV5 2S32140			139	42,3	34,8	1.472,0	41,7	1.764,0	46,9	1.984,0	52,1	2.204,0	65,3
NV5 2S32151			152	37,8	38,0	1.436,0	45,6	1.724,0	51,3	1.939,0	57,0	2.155,0	73,0
NV5 2S32176			178	32,5	44,5	1.446,0	53,4	1.736,0	60,1	1.953,0	66,7	2.168,0	84,5
NV5 2S32202			203	28,9	50,8	1.468,0	60,9	1.760,0	68,5	1.980,0	76,1	2.199,0	96,9
NV5 2S32252			254	22,2	63,5	1.410,0	76,2	1.692,0	85,7	1.903,0	95,2	2.113,0	121,0
NV5 2S32303	305	18,3	76,3	1.396,0	91,5	1.674,0	102,9	1.883,0	114,0	2.086,0	147,0		
NV5 2S38050	40	20	51	182,0	12,8	2.330,0	15,3	2.785,0	17,2	3.130,0	19,1	3.476,0	21,4
NV5 2S38065			64	140,0	16,0	2.240,0	19,2	2.688,0	21,6	3.024,0	24,0	3.360,0	26,8
NV5 2S38075			76	108,0	19,0	2.052,0	22,8	2.462,0	25,7	2.776,0	28,5	3.078,0	32,7
NV5 2S38090			89	90,7	22,3	2.023,0	26,7	2.422,0	30,0	2.721,0	33,3	3.020,0	39,0
NV5 2S38101			102	81,0	25,5	2.066,0	30,6	2.479,0	34,4	2.786,0	38,2	3.094,0	44,1
NV5 2S38115			115	71,8	28,8	2.068,0	34,5	2.477,0	38,8	2.786,0	43,1	3.095,0	50,6
NV5 2S38126			127	62,7	31,8	1.994,0	38,1	2.389,0	42,9	2.690,0	47,6	2.985,0	55,9
NV5 2S38140			139	57,5	34,8	2.001,0	41,7	2.398,0	46,9	2.697,0	52,1	2.996,0	61,8
NV5 2S38151			152	51,6	38,0	1.961,0	45,6	2.353,0	51,3	2.647,0	57,0	2.941,0	67,5
NV5 2S38176			178	44,1	44,5	1.962,0	53,4	2.355,0	60,1	2.650,0	66,7	2.941,0	77,2
NV5 2S38202			203	36,7	50,8	1.864,0	60,9	2.235,0	68,5	2.514,0	76,1	2.793,0	91,8
NV5 2S38252			254	30,1	63,5	1.911,0	76,2	2.294,0	85,7	2.580,0	95,2	2.866,0	113,0
NV5 2S38303			305	24,6	76,3	1.877,0	91,5	2.251,0	102,9	2.531,0	114,0	2.804,0	138,0
NV5 2S51065			50	25	64	209,0	16,0	3.344,0	19,2	4.013,0	21,6	4.514,0	24,0
NV5 2S51075	76	168,0			19,0	3.192,0	22,8	3.830,0	25,7	4.318,0	28,5	4.788,0	34,9
NV5 2S51090	89	140,0			22,3	3.122,0	26,7	3.738,0	30,0	4.200,0	33,3	4.662,0	39,2
NV5 2S51101	102	119,0			25,5	3.035,0	30,6	3.641,0	34,4	4.094,0	38,2	4.546,0	47,3
NV5 2S51115	115	106,0			28,8	3.053,0	34,5	3.657,0	38,8	4.113,0	43,1	4.569,0	52,6
NV5 2S51126	127	97,0			31,8	3.085,0	38,1	3.696,0	42,9	4.161,0	47,6	4.617,0	59,8
NV5 2S51140	139	87,0			34,8	3.028,0	41,7	3.628,0	46,9	4.080,0	52,1	4.533,0	65,1
NV5 2S51160	160	80,0			40,0	3.040,0	48,0	3.648,0	51,3	4.104,0	57,0	4.560,0	70,8
NV5 2S51176	178	69,5			44,5	3.093,0	53,4	3.711,0	60,1	4.177,0	66,7	4.636,0	84,2
NV5 2S51202	203	59,8			50,8	3.038,0	60,9	3.642,0	68,5	4.096,0	76,1	4.551,0	96,5
NV5 2S51229	229	50,9			57,3	2.917,0	68,7	3.497,0	77,3	3.935,0	85,8	4.367,0	108,0
NV5 2S51252	254	46,0			63,5	2.921,0	76,2	3.505,0	85,7	3.942,0	95,2	4.179,0	122,0
NV5 2S51303	305	38,6			76,3	2.945,0	91,5	3.532,0	102,9	3.972,0	114,0	4.400,0	147,0
NV5 2S63075	63	38			76	320,0	19,0	6.080,0	22,8	7.296,0	25,7	8.224,0	28,5
NV5 2S63090			89	260,0	22,3	5.798,0	26,7	6.942,0	30,0	7.800,0	33,3	8.658,0	36,5
NV5 2S63101			102	221,0	25,5	5.636,0	30,6	6.763,0	34,4	7.602,0	38,2	8.442,0	43,6
NV5 2S63115			115	187,0	28,8	5.386,0	34,5	6.452,0	38,8	7.256,0	43,1	8.060,0	48,9
NV5 2S63126			127	168,0	31,8	5.342,0	38,1	6.401,0	42,9	7.207,0	47,6	7.997,0	54,2
NV5 2S63151			152	136,0	38,0	5.168,0	45,6	6.202,0	51,3	6.977,0	57,0	7.752,0	65,7
NV5 2S63176			178	114,0	44,5	5.073,0	53,4	6.088,0	60,1	6.851,0	66,7	7.604,0	76,5
NV5 2S63202			203	100,0	50,8	5.080,0	60,9	6.090,0	68,5	6.850,0	76,1	7.610,0	88,0
NV5 2S63229			229	89,2	57,3	5.111,0	68,7	6.128,0	77,3	6.895,0	85,8	7.653,0	104,0
NV5 2S63252			254	78,4	63,5	4.978,0	76,2	5.974,0	85,7	6.719,0	95,2	7.464,0	112,0
NV5 2S63303			305	64,7	76,3	4.937,0	91,5	5.920,0	102,9	6.658,0	114,0	7.373,0	134,0
NV5 2S63315			315	60,0	78,8	4.725,0	94,5	5.670,0	106,3	6.378,8	118,1	7.087,5	140,0
NV5 2S63350			350	55,8	87,5	4.882,5	105,0	5.859,0	118,1	6.591,4	131,3	7.323,8	150,0
NV5 2S63400			400	48,5	100,0	4.850,0	120,0	5.582,0	135,0	6.547,5	150,0	7.275,0	160,0

kursiv: keine ISO Norm

NV 5 3S ISO 10243

Systemfedern für schwere Last

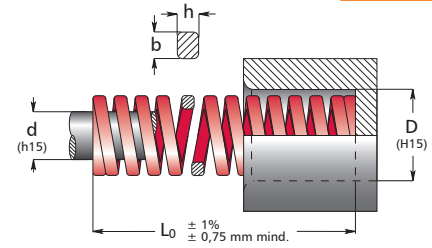

Bestell-Nr.	D	d	L <sub>0</sub>	R	A		B		C		D		E
	∅ mm	∅ mm	mm	±10% N/mm	20 % L <sub>0</sub>		25 % L <sub>0</sub>		27,5 % L <sub>0</sub>		30 % L <sub>0</sub>		⚠ s mm
					s	F	s	F	s	F	s	F	s
NV53S10025	10	5	25	23,0	5,0	115,0	6,3	144,9	6,9	158,7	7,5	172,5	9,2
NV53S10032			32	17,5	6,4	112,0	8,0	140,0	8,8	154,0	9,6	168,0	12,1
NV53S10038			38	14,8	7,6	112,5	9,5	140,6	10,5	155,4	11,4	168,7	13,2
NV53S10045			44	13,0	8,8	114,4	11,0	143,0	12,1	157,3	13,2	171,6	15,1
NV53S10050			51	11,2	10,2	114,2	12,8	143,4	14,0	156,8	15,3	171,4	19,5
NV53S10065			64	9,2	12,8	117,8	16,0	147,2	17,6	161,9	19,2	176,6	21,8
NV53S10075			76	7,5	15,2	114,0	19,0	142,5	20,9	156,8	22,8	171,0	27,9
NV53S10115			115	4,8	23,0	110,4	29,0	139,2	32,0	153,6	34,5	165,6	56,0
NV53S10303			305	1,9	61,0	115,9	76,3	145,0	83,9	159,4	91,5	173,9	127,0
NV53S13025	12,5	6,3	25	42,1	5,0	210,5	6,3	265,2	6,9	290,5	7,5	315,8	9,8
NV53S13032			32	33,2	6,4	212,5	8,0	265,6	8,8	292,2	9,6	318,7	13,6
NV53S13038			38	29,3	7,6	222,7	9,5	278,4	10,5	307,7	11,4	334,0	14,6
NV53S13045			44	24,6	8,8	216,5	11,0	270,6	12,1	297,7	13,2	324,7	18,1
NV53S13050			51	19,6	10,2	199,9	12,8	250,9	14,0	274,4	15,3	299,9	22,3
NV53S13065			64	15,0	12,8	192,0	16,0	240,0	17,6	264,0	19,2	288,0	27,3
NV53S13075			76	13,2	15,2	200,6	19,0	250,8	20,9	275,9	22,8	301,0	33,1
NV53S13090			89	11,4	17,8	202,9	22,3	254,2	24,5	279,3	26,7	304,4	38,9
NV53S13101			102	8,4	20,4	171,4	25,5	214,2	28,1	236,0	30,6	257,0	43,8
NV53S13303	305	3,2	61,0	195,2	76,3	244,2	83,9	268,5	91,5	292,8	140,0		
NV53S16025	16	8	25	75,7	5,0	378,5	6,3	476,9	6,9	522,3	7,5	567,8	8,4
NV53S16032			32	60,2	6,4	385,3	8,0	481,6	8,8	529,8	9,6	577,9	10,5
NV53S16038			38	50,8	7,6	386,1	9,5	482,6	10,5	533,4	11,4	579,1	13,6
NV53S16045			44	42,8	8,8	376,6	11,0	470,8	12,1	517,9	13,2	565,0	15,9
NV53S16050			51	37,1	10,2	378,4	12,8	474,9	14,0	519,4	15,3	567,6	18,9
NV53S16065			64	30,3	12,8	387,8	16,0	484,8	17,6	533,3	19,2	581,8	24,9
NV53S16075			76	25,7	15,2	390,6	19,0	488,3	20,9	537,1	22,8	586,0	29,2
NV53S16090			89	21,7	17,8	386,3	22,3	483,9	24,5	531,7	26,7	579,4	34,5
NV53S16101			102	18,9	20,4	385,6	25,5	482,0	28,1	531,1	30,6	578,3	39,1
NV53S16115	115	15,7	23,0	361,1	28,8	452,2	31,6	496,1	34,5	541,7	44,0		
NV53S16303	305	6,3	61,0	384,3	76,3	480,7	83,9	528,6	91,5	576,5	104,0		
NV53S19025	20	10	25	216,0	5,0	1.080,0	6,3	1.361,0	6,9	1.490,0	7,5	1.620,0	8,3
NV53S19032			32	168,0	6,4	1.075,0	8,0	1.344,0	8,8	1.478,0	9,6	1.613,0	10,9
NV53S19038			38	129,0	7,6	980,0	9,5	1.226,0	10,5	1.355,0	11,4	1.471,0	12,5
NV53S19045			44	112,0	8,8	986,0	11,0	1.232,0	12,1	1.355,0	13,2	1.478,0	15,0
NV53S19050			51	94,0	10,2	959,0	12,8	1.203,0	14,0	1.316,0	15,3	1.438,0	17,6
NV53S19065			64	72,1	12,8	923,0	16,0	1.154,0	17,6	1.269,0	19,2	1.384,0	22,6
NV53S19075			76	59,7	15,2	907,0	19,0	1.134,0	20,9	1.248,0	22,8	1.361,0	27,5
NV53S19090			89	50,5	17,8	899,0	22,3	1.126,0	24,5	1.237,0	26,7	1.348,0	31,7
NV53S19101			102	44,2	20,4	902,0	25,5	1.127,0	28,1	1.242,0	30,6	1.353,0	37,5
NV53S19115	115	38,4	23,0	883,0	28,8	1.106,0	31,6	1.213,0	34,5	1.325,0	42,6		
NV53S19126	127	34,1	25,4	866,0	31,8	1.084,0	34,9	1.190,0	38,1	1.299,0	45,5		
NV53S19140	139	31,0	27,8	862,0	34,8	1.079,0	38,2	1.184,0	41,7	1.293,0	50,1		
NV53S19151	152	28,2	30,4	857,0	38,0	1.072,0	41,8	1.179,0	45,6	1.286,0	55,8		
NV53S19303	305	14,0	61,0	854,0	76,3	1.068,0	83,9	1.175,0	91,5	1.281,0	114,0		
NV53S26025	25	12,5	25	375,0	5,0	1.875,0	6,3	2.363,0	6,9	2.588,0	7,5	2.813,0	8,5
NV53S26032			32	297,0	6,4	1.901,0	8,0	2.376,0	8,8	2.614,0	9,6	2.851,0	11,0
NV53S26038			38	219,0	7,6	1.664,0	9,5	2.081,0	10,5	2.300,0	11,4	2.497,0	12,6
NV53S26045			44	187,0	8,8	1.646,0	11,0	2.057,0	12,1	2.263,0	13,2	2.468,0	14,8
NV53S26050			51	156,0	10,2	1.591,0	12,8	1.997,0	14,0	2.184,0	15,3	2.387,0	17,9
NV53S26065			64	123,0	12,8	1.574,0	16,0	1.968,0	17,6	2.165,0	19,2	2.362,0	23,1
NV53S26075			76	99,0	15,2	1.505,0	19,0	1.881,0	20,9	2.069,0	22,8	2.257,0	26,3
NV53S26090			89	84,0	17,8	1.495,0	22,3	1.873,0	24,5	2.058,0	26,7	2.243,0	30,5
NV53S26101			102	73,0	20,4	1.489,0	25,5	1.862,0	28,1	2.051,0	30,6	2.234,0	37,3
NV53S26115	115	65,0	23,0	1.495,0	28,8	1.872,0	31,6	2.054,0	34,5	2.243,0	41,9		
NV53S26126	127	57,7	25,4	1.466,0	31,8	1.835,0	34,9	2.014,0	38,1	2.198,0	46,2		
NV53S26140	139	52,7	27,8	1.465,0	34,8	1.834,0	38,2	2.013,0	41,7	2.198,0	49,3		
NV53S26151	152	47,8	30,4	1.453,0	38,0	1.816,0	41,8	1.998,0	45,6	2.180,0	55,7		
NV53S26176	178	41,0	35,6	1.460,0	44,5	1.825,0	49,0	2.009,0	53,4	2.189,0	65,1		
NV53S26202	203	35,8	40,6	1.453,0	50,8	1.819,0	55,8	1.998,0	60,9	2.180,0	74,5		
NV53S26303	305	22,9	61,0	1.397,0	76,3	1.747,0	83,9	1.921,0	91,5	2.095,0	110,0		

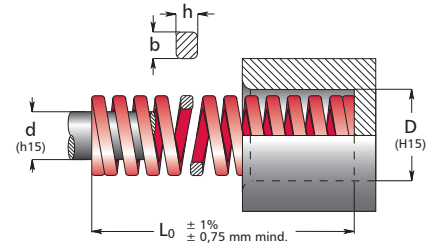

Bestell-Nr.	D		L <sub>0</sub>	R ±10%	A 20 % L <sub>0</sub>		B 25 % L <sub>0</sub>		C 27,5 % L <sub>0</sub>		D 30 % L <sub>0</sub>		E 		
	ø mm	ø mm			s mm	F N	s mm	F N	s mm	F N	s mm	F N		s mm	F N
NV53S32038	32	16	38	388,0	7,6	2.949,0	9,5	3.686,0	10,5	4.074,0	11,4	4.423,0	12,5		
NV53S32045			44	324,0	8,8	2.851,0	11,0	3.564,0	12,1	3.920,0	13,2	4.277,0	14,9		
NV53S32050			51	272,0	10,2	2.774,0	12,8	3.482,0	14,0	3.808,0	15,3	4.162,0	17,8		
NV53S32065			64	212,0	12,8	2.714,0	16,0	3.392,0	17,6	3.731,0	19,2	4.070,0	22,4		
NV53S32075			76	172,0	15,2	2.614,0	19,0	3.268,0	20,9	3.595,0	22,8	3.922,0	26,1		
NV53S32090			89	141,0	17,8	2.510,0	22,3	3.144,0	24,5	3.455,0	26,7	3.765,0	30,8		
NV53S32101			102	122,0	20,4	2.489,0	25,5	3.111,0	28,1	3.428,0	30,6	3.733,0	36,8		
NV53S32115			115	107,0	23,0	2.461,0	28,8	3.082,0	31,6	3.381,0	34,5	3.692,0	41,4		
NV53S32126			127	93,0	25,4	2.362,0	31,8	2.957,0	34,9	3.246,0	38,1	3.543,0	44,4		
NV53S32140			139	86,0	27,8	2.391,0	34,8	2.993,0	38,2	3.285,0	41,7	3.586,0	48,5		
NV53S32151			152	78,0	30,4	2.371,0	38,0	2.964,0	41,8	3.260,0	45,6	3.557,0	54,8		
NV53S32176			178	67,2	35,6	2.392,0	44,5	2.990,0	49,0	3.293,0	53,4	3.588,0	63,6		
NV53S32202			203	59,1	40,6	2.399,0	50,8	3.002,0	55,8	3.298,0	60,9	3.599,0	72,5		
NV53S32252			254	46,4	50,8	2.357,0	63,5	2.946,0	69,9	3.243,0	76,2	3.536,0	92,8		
NV53S32303	305	38,0	61,0	2.318,0	76,3	2.899,0	83,9	3.188,0	91,5	3.477,0	112,0				
NV53S38050	40	20	51	350,0	10,2	3.570,0	12,8	4.480,0	14,0	4.900,0	15,3	5.355,0	17,0		
NV53S38065			64	269,0	12,8	3.443,0	16,0	4.304,0	17,6	4.734,0	19,2	5.165,0	21,9		
NV53S38075			76	219,0	15,2	3.329,0	19,0	4.161,0	20,9	4.577,0	22,8	4.993,0	26,7		
NV53S38090			89	190,0	17,8	3.382,0	22,3	4.237,0	24,5	4.655,0	26,7	5.073,0	31,3		
NV53S38101			102	163,0	20,4	3.325,0	25,5	4.157,0	28,1	4.580,0	30,6	4.988,0	37,1		
NV53S38115			115	142,0	23,0	3.266,0	28,8	4.090,0	31,6	4.487,0	34,5	4.899,0	41,0		
NV53S38126			127	128,0	25,4	3.251,0	31,8	4.070,0	34,9	4.467,0	38,1	4.877,0	46,5		
NV53S38140			139	115,0	27,8	3.197,0	34,8	4.002,0	38,2	4.393,0	41,7	4.796,0	53,1		
NV53S38151			152	105,0	30,4	3.192,0	38,0	3.990,0	41,8	4.389,0	45,6	4.788,0	56,1		
NV53S38176			178	89,0	35,6	3.168,0	44,5	3.961,0	49,0	4.361,0	53,4	4.753,0	67,4		
NV53S38202			203	77,0	40,6	3.126,0	50,8	3.912,0	55,8	4.297,0	60,9	4.689,0	76,2		
NV53S38252			254	61,0	50,8	3.099,0	63,5	3.874,0	69,9	4.264,0	76,2	4.648,0	96,2		
NV53S38303			305	51,0	61,0	3.111,0	76,3	3.891,0	83,9	4.279,0	91,5	4.667,0	115,0		
NV53S51065			50	25	64	413,0	12,8	5.286,0	16,0	6.608,0	17,6	7.269,0	19,2	7.930,0	22,4
NV53S51075	76	339,0			15,2	5.153,0	19,0	6.441,0	20,9	7.085,0	22,8	7.729,0	26,5		
NV53S51090	89	288,0			17,8	5.126,0	22,3	6.422,0	24,5	7.056,0	26,7	7.690,0	31,5		
NV53S51101	102	245,0			20,4	4.998,0	25,5	6.248,0	28,1	6.885,0	30,6	7.497,0	37,6		
NV53S51115	115	215,0			23,0	4.945,0	28,8	6.192,0	31,6	6.794,0	34,5	7.418,0	42,7		
NV53S51126	127	192,0			25,4	4.877,0	31,8	6.106,0	34,9	6.701,0	38,1	7.315,0	47,5		
NV53S51140	139	168,0			27,8	4.670,0	34,8	5.846,0	38,2	6.418,0	41,7	7.006,0	51,8		
NV53S51151	152	154,0			30,4	4.682,0	38,0	5.852,0	41,8	6.437,0	45,6	7.022,0	57,8		
NV53S51176	178	134,0			35,6	4.770,0	44,5	5.963,0	49,0	6.566,0	53,4	7.156,0	68,5		
NV53S51202	203	117,0			40,6	4.750,0	50,8	5.944,0	55,8	6.529,0	60,9	7.125,0	77,6		
NV53S51252	254	89,0			50,8	4.521,0	63,5	5.652,0	69,9	6.221,0	76,2	6.782,0	97,9		
NV53S51303	305	73,0			61,0	4.453,0	76,3	5.570,0	83,9	6.125,0	91,5	6.680,0	121,0		
NV53S63075	63	38			76	618,0	15,2	9.394,0	19,0	11.742,0	20,9	12.916,0	22,8	14.090,0	24,7
NV53S63090					89	515,0	17,8	9.167,0	22,3	11.485,0	24,5	12.618,0	26,7	13.751,0	30,0
NV53S63101			102	438,0	20,4	8.935,0	25,5	11.169,0	28,1	12.308,0	30,6	13.403,0	35,1		
NV53S63115			115	370,0	23,0	8.510,0	28,8	10.656,0	31,6	11.692,0	34,5	12.765,0	37,5		
NV53S63126			127	333,0	25,4	8.458,0	31,8	10.589,0	34,9	11.622,0	38,1	12.687,0	45,9		
NV53S63140			139	298,0	27,8	8.294,0	34,8	10.368,0	38,2	11.404,0	41,7	12.441,0	50,0		
NV53S63151			152	269,0	30,4	8.178,0	38,0	10.222,0	41,8	11.244,0	45,6	12.266,0	56,5		
NV53S63176			178	226,0	35,6	8.046,0	44,5	10.057,0	49,0	11.074,0	53,4	12.068,0	66,8		
NV53S63202			203	198,0	40,6	8.039,0	50,8	10.058,0	55,8	11.048,0	60,9	12.058,0	78,8		
NV53S63252			254	155,0	50,8	7.874,0	63,5	9.843,0	69,9	10.835,0	76,2	11.811,0	102,0		
NV53S63303			305	128,0	61,0	7.808,0	76,3	9.766,0	83,9	10.739,0	91,5	11.712,0	122,0		
NV53S63315			315	133,0	63,0	8.379,0	78,8	10.473,8	86,6	11.521,1	94,5	12.568,5	108,0		
NV53S63350			350	115,0	70,0	8.050,0	87,5	10.062,5	96,3	11.068,8	105	12.075,0	110,0		
NV53S63400			400	98,0	80,0	7.840,0	100	9.800,0	110	10.780,0	120	11.760,0	125,0		

kursiv: keine ISO Norm

NV 5 4S ISO 10243

Systemfedern für extra schwere Last

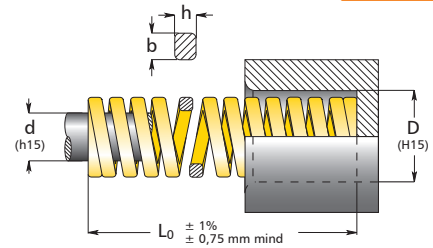

Bestell-Nr.	D	d	L <sub>0</sub>	R	A		B		C		D		E
	∅ mm	∅ mm	mm	±10%	s	F	s	F	s	F	s	F	s
					mm	N	mm	N	mm	N	mm	N	mm
NV 5 4S10025	10	5	25	36,8	4,3	158,2	5,0	184,0	5,6	206,1	6,2	228,2	7,7
NV 5 4S10032					5,4	150,7	6,4	178,6	7,2	200,9	8,0	223,2	10,6
NV 5 4S10038					6,5	154,1	7,6	180,1	8,6	203,8	9,5	225,2	12,6
NV 5 4S10045					7,5	144,0	8,8	169,0	9,9	190,1	11,0	211,2	13,8
NV 5 4S10050					8,7	143,6	10,2	168,3	11,5	189,8	12,7	209,6	16,2
NV 5 4S10065					10,9	143,9	12,8	169,0	14,4	190,1	16,0	211,2	20,4
NV 5 4S10075					12,9	140,6	15,2	165,7	17,1	186,4	19,0	207,1	25,2
NV 5 4S10303					51,9	134,9	61,0	158,6	68,6	178,4	76,3	198,4	111,0
NV 5 4S13025	12,5	6,3	25	58,5	4,3	251,6	5,0	292,5	5,6	327,6	6,2	362,7	8,1
NV 5 4S13032					5,4	237,1	6,4	281,0	7,2	316,1	8,0	351,2	9,9
NV 5 4S13038					6,5	234,0	7,6	273,6	8,6	309,6	9,5	342,0	12,9
NV 5 4S13045					7,5	227,3	8,8	266,6	9,9	300,0	11,0	333,3	14,1
NV 5 4S13050					8,7	227,9	10,2	267,2	11,5	301,3	12,7	332,7	17,4
NV 5 4S13065					10,9	231,1	12,8	271,4	14,4	305,3	16,0	339,2	21,0
NV 5 4S13075					12,9	220,6	15,2	259,9	17,1	292,4	19,0	324,9	26,4
NV 5 4S13090					14,5	219,0	17,8	258,1	20,0	290,0	22,2	321,9	31,5
NV 5 4S13101	15,1	219,0	17,8	258,1	20,0	290,0	22,2	321,9	31,5				
NV 5 4S13101	17,3	219,7	20,4	259,1	23,0	292,1	25,5	323,9	36,0				
NV 5 4S13303	51,9	223,2	61,0	262,3	68,6	295,0	76,3	328,1	111,0				
NV 5 4S16025	16	8	25	118,0	4,3	507,4	5,0	590,0	5,6	660,8	6,2	731,6	8,5
NV 5 4S16032					5,4	480,6	6,4	569,6	7,2	640,8	8,0	712,0	11,0
NV 5 4S16038					6,5	468,7	7,6	548,0	8,6	620,1	9,5	685,0	13,2
NV 5 4S16045					7,5	456,8	8,8	535,9	9,9	602,9	11,0	669,9	14,7
NV 5 4S16050					8,7	455,0	10,2	533,5	11,5	601,5	12,7	664,2	17,7
NV 5 4S16065					10,9	449,1	12,8	527,4	14,4	593,3	16,0	659,2	21,9
NV 5 4S16075					12,9	439,9	15,2	518,3	17,1	583,1	19,0	647,9	27,8
NV 5 4S16090					15,1	445,5	17,8	525,1	20,0	590,0	22,2	654,9	31,2
NV 5 4S16101	17,3	442,9	20,4	522,2	23,0	588,8	25,5	652,8	37,9				
NV 5 4S16101	19,6	439,0	23,0	515,2	25,9	580,2	28,7	642,9	44,5				
NV 5 4S16115	22,4	439,0	23,0	515,2	25,9	580,2	28,7	642,9	44,5				
NV 5 4S16303	51,9	436,0	61,0	512,4	68,6	576,2	76,3	640,9	113,0				
NV 5 4S19025	20	10	25	293,0	4,3	1.260,0	5,0	1.465,0	5,6	1.641,0	6,2	1.817,0	6,9
NV 5 4S19032					5,4	1.210,0	6,4	1.434,0	7,2	1.613,0	8,0	1.792,0	9,4
NV 5 4S19038					6,5	1.151,0	7,6	1.345,0	8,6	1.522,0	9,5	1.682,0	12,0
NV 5 4S19045					7,5	1.118,0	8,8	1.311,0	9,9	1.475,0	11,0	1.639,0	13,5
NV 5 4S19050					8,7	1.114,0	10,2	1.306,0	11,5	1.472,0	12,7	1.626,0	16,2
NV 5 4S19065					10,9	1.079,0	12,8	1.267,0	14,4	1.426,0	16,0	1.584,0	21,2
NV 5 4S19075					12,9	1.054,0	15,2	1.242,0	17,1	1.397,0	19,0	1.552,0	24,7
NV 5 4S19090					15,1	1.049,0	17,8	1.237,0	20,0	1.390,0	22,2	1.543,0	28,8
NV 5 4S19101	17,3	1.048,0	20,4	1.236,0	23,0	1.394,0	25,5	1.545,0	34,8				
NV 5 4S19115	19,6	1.039,0	23,0	1.219,0	25,9	1.373,0	28,7	1.521,0	39,0				
NV 5 4S19126	21,6	1.026,0	25,4	1.207,0	28,6	1.359,0	31,7	1.506,0	43,0				
NV 5 4S19140	23,6	1.015,0	27,8	1.195,0	31,3	1.346,0	34,7	1.492,0	45,3				
NV 5 4S19151	25,8	1.006,0	30,4	1.186,0	34,2	1.334,0	38,0	1.482,0	50,4				
NV 5 4S19303	51,9	1.038,0	61,0	1.220,0	68,6	1.372,0	76,3	1.526,0	103,0				
NV 5 4S26025	25	12,5	25	459,0	4,3	1.974,0	5,0	2.295,0	5,6	2.570,0	6,3	2.892,0	6,7
NV 5 4S26032					5,4	2.020,0	6,4	2.394,0	7,2	2.693,0	8,0	2.992,0	10,7
NV 5 4S26038					6,5	1.950,0	7,6	2.280,0	8,6	2.580,0	9,5	2.850,0	12,0
NV 5 4S26045					7,5	1.830,0	8,8	2.147,0	9,9	2.416,0	11,0	2.684,0	14,4
NV 5 4S26050					8,7	1.810,0	10,2	2.122,0	11,5	2.392,0	12,8	2.662,0	17,4
NV 5 4S26065					10,9	1.755,0	12,8	2.061,0	14,4	2.318,0	16,0	2.576,0	21,4
NV 5 4S26075					12,9	1.690,0	15,2	1.991,0	17,1	2.240,0	19,0	2.489,0	26,9
NV 5 4S26090					15,1	1.676,0	17,8	1.976,0	20,0	2.220,0	22,3	2.475,0	30,9
NV 5 4S26101	17,3	1.666,0	20,4	1.965,0	23,0	2.210,0	25,5	2.456,0	36,7				
NV 5 4S26115	19,6	1.680,0	23,0	1.971,0	25,9	2.217,0	28,8	2.468,0	40,3				
NV 5 4S26126	21,6	1.648,0	25,4	1.938,0	28,6	2.180,0	31,8	2.426,0	45,1				
NV 5 4S26140	23,6	1.558,0	27,8	1.835,0	31,3	2.066,0	34,8	2.297,0	47,6				
NV 5 4S26151	25,8	1.638,0	30,4	1.930,0	34,2	2.172,0	38,0	2.413,0	53,5				
NV 5 4S26176	30,3	1.633,0	35,6	1.919,0	40,1	2.159,0	44,5	2.399,0	63,9				
NV 5 4S26202	34,5	1.622,0	40,6	1.908,0	45,7	2.147,0	50,8	2.388,0	70,2				
NV 5 4S26303	51,9	1.604,0	61,0	1.885,0	68,6	2.121,0	76,3	2.358,0	110,0				

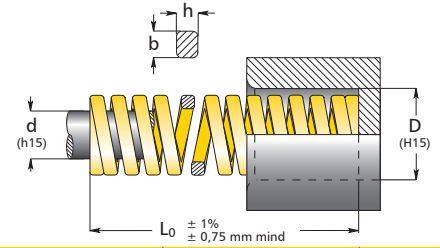

Bestell-Nr.	D	d	L <sub>0</sub>	R ±10%	A 17 % L <sub>0</sub>		B 20 % L <sub>0</sub>		C 22,5 % L <sub>0</sub>		D 25 % L <sub>0</sub>		E		
	ø mm	ø mm	mm	N/mm	s mm	F N	s mm	F N	s mm	F N	s mm	F N	s mm		
NV 54S32038	32	16	38	480,0	6,5	3.120,0	7,6	3.648,0	8,6	4.128,0	9,5	4.560,0	11,4		
NV 54S32045			44	390,0	7,5	2.925,0	8,8	3.432,0	9,9	3.861,0	11,0	4.290,0	13,7		
NV 54S32050			51	336,0	8,7	2.923,0	10,2	3.427,0	11,5	3.864,0	12,7	4.267,0	15,6		
NV 54S32065			64	269,0	10,9	2.932,0	12,8	3.443,0	14,4	3.874,0	16,0	4.304,0	20,0		
NV 54S32075			76	219,0	12,9	2.825,0	15,2	3.329,0	17,1	3.745,0	19,0	4.161,0	24,4		
NV 54S32090			89	180,0	15,1	2.718,0	17,8	3.204,0	20,0	3.600,0	22,2	3.996,0	29,7		
NV 54S32101			102	155,0	17,3	2.682,0	20,4	3.162,0	23,0	3.565,0	25,5	3.953,0	35,1		
NV 54S32115			115	140,0	19,6	2.744,0	23,0	3.220,0	25,9	3.626,0	28,7	4.018,0	39,0		
NV 54S32126			127	124,0	21,6	2.678,0	25,4	3.150,0	28,6	3.546,0	31,7	3.931,0	42,8		
NV 54S32140			139	112,0	23,6	2.643,0	27,8	3.114,0	31,3	3.506,0	34,7	3.886,0	48,0		
NV 54S32151			152	102,0	25,8	2.632,0	30,4	3.101,0	34,2	3.488,0	38,0	3.876,0	52,4		
NV 54S32176			178	88,2	30,3	2.672,0	35,6	3.140,0	40,1	3.537,0	44,5	3.925,0	60,9		
NV 54S32202			203	76,0	34,5	2.622,0	40,6	3.086,0	45,7	3.473,0	50,7	3.853,0	69,2		
NV 54S32252			254	60,8	43,2	2.627,0	50,8	3.089,0	57,2	3.478,0	64,0	3.861,0	88,1		
NV 54S32303	305	49,0	51,9	2.543,0	61,0	2.989,0	68,6	3.361,0	76,3	3.739,0	104,0				
NV 54S38050	40	20	51	628,0	8,7	5.464,0	10,2	6.406,0	11,5	7.222,0	12,7	7.976,0	15,0		
NV 54S38065			64	487,0	10,9	5.308,0	12,8	6.234,0	14,4	7.013,0	16,0	7.792,0	19,5		
NV 54S38075			76	379,0	12,9	4.889,0	15,2	5.761,0	17,1	6.481,0	19,0	7.201,0	23,3		
NV 54S38090			89	321,0	15,1	4.847,0	17,8	5.714,0	20,0	6.420,0	22,2	7.126,0	26,7		
NV 54S38101			102	281,0	17,3	4.861,0	20,4	5.732,0	23,0	6.463,0	25,5	7.165,0	33,8		
NV 54S38115			115	245,0	19,6	4.802,0	23,0	5.635,0	25,9	6.346,0	28,7	7.032,0	36,2		
NV 54S38126			127	221,0	21,6	4.774,0	25,4	5.613,0	28,6	6.321,0	31,7	7.006,0	40,7		
NV 54S38140			139	185,0	23,6	4.366,0	27,8	5.143,0	31,3	5.791,0	34,7	6.420,0	42,0		
NV 54S38151			152	168,0	25,8	4.334,0	30,4	5.107,0	34,2	5.746,0	38,0	6.384,0	49,6		
NV 54S38176			178	150,0	30,3	4.545,0	35,6	5.340,0	40,1	6.015,0	44,5	6.675,0	56,5		
NV 54S38202			203	132,0	34,5	4.554,0	40,6	5.359,0	45,7	6.032,0	50,7	6.692,0	67,1		
NV 54S38252			254	107,0	43,2	4.622,0	50,8	5.436,0	57,2	6.120,0	64,0	6.848,0	86,3		
NV 54S38303			305	87,8	51,9	4.557,0	61,0	5.356,0	68,6	6.023,0	76,3	6.699,0	104,0		
NV 54S51065			50	25	64	709,0	10,9	7.728,0	12,8	9.075,0	14,4	10.210,0	16,0	11.344,0	19,3
NV 54S51075	76	572,0			12,9	7.379,0	15,2	8.694,0	17,1	9.781,0	19,0	10.868,0	24,2		
NV 54S51090	89	475,0			15,1	7.173,0	17,8	8.455,0	20,0	9.500,0	22,2	10.545,0	28,0		
NV 54S51101	102	405,0			17,3	7.007,0	20,4	8.262,0	23,0	9.315,0	25,5	10.328,0	33,5		
NV 54S51115	115	352,0			19,6	6.899,0	23,0	8.096,0	25,9	9.117,0	28,7	10.102,0	38,6		
NV 54S51126	127	316,0			21,6	6.826,0	25,4	8.026,0	28,6	9.038,0	31,7	10.017,0	41,4		
NV 54S51140	139	289,0			23,6	6.820,0	27,8	8.034,0	31,3	9.046,0	34,7	10.028,0	47,3		
NV 54S51151	152	255,0			25,8	6.579,0	30,4	7.752,0	34,2	8.721,0	38,0	9.690,0	50,2		
NV 54S51176	178	215,0			30,3	6.515,0	35,6	7.654,0	40,1	8.622,0	44,5	9.568,0	61,1		
NV 54S51202	203	187,0			34,5	6.452,0	40,6	7.592,0	45,7	8.546,0	50,7	9.481,0	67,7		
NV 54S51252	254	153,0			43,2	6.610,0	50,8	7.772,0	57,2	8.752,0	64,0	9.792,0	87,0		
NV 54S51303	305	127,0			51,9	6.591,0	61,0	7.747,0	68,6	8.712,0	76,3	9.690,0	104,0		
NV 54S63075	63	38			76	952,0	12,9	12.281,0	15,2	14.470,0	-	-	-	-	15,5
NV 54S63090					89	819,0	15,1	12.367,0	17,8	14.578,0	-	-	-	-	-
NV 54S63101			102	700,0	17,3	12.110,0	20,4	14.280,0	23,0	16.100,0	25,5	17.850,0	30,7		
NV 54S63115			115	620,0	19,6	12.152,0	23,0	14.260,0	25,9	16.058,0	28,7	17.860,0	34,9		
NV 54S63126			127	565,0	21,6	12.204,0	25,4	14.351,0	28,6	16.159,0	31,7	17.967,0	38,0		
NV 54S63151			152	458,0	25,8	11.816,0	30,4	13.923,0	34,2	15.664,0	38,0	17.404,0	47,2		
NV 54S63176			178	384,0	30,3	11.635,0	35,6	13.670,0	40,1	15.398,0	44,5	17.088,0	55,8		
NV 54S63202			203	337,0	34,5	11.627,0	40,6	13.682,0	45,7	15.401,0	50,7	17.120,0	64,8		
NV 54S63252			254	263,0	43,2	11.362,0	50,8	13.360,0	57,2	15.044,0	63,5	16.701,0	86,7		
NV 54S63303			305	218,0	51,9	11.314,0	61,0	13.298,0	68,6	14.955,0	76,3	16.633,0	106,0		
NV 54S63315			315	199,0	54,0	10.656,5	63,0	12.537,0	71,0	14.104,0	79,0	15.671,0	81,0		
NV 54S63350			350	180,0	60,0	10.710,0	70,0	12.600,0	79,0	14.175,0	88,0	15.750,0	90,0		
NV 54S63400			400	156,0	68,0	10.608,0	80,0	12.480,0	90,0	14.040,0	100,0	15.600,0	103,0		

NV 5 W **NEU**

# Systemfedern für extremst hohe Last

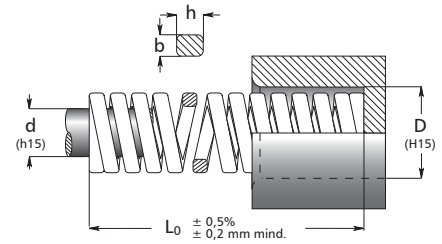

Bestellnummer	D		L <sub>0</sub>	R ±10%	S <sub>max</sub>	F <sub>max</sub>
	b x h					
	∅ mm	∅ mm	mm	N/mm	mm	N
	mm					
NV 5 W16020	16,0	6,3	20	1.818,0	2,0	4.000
NV 5 W16035			35	1.000,0	4,0	
NV 5 W16050	 4,6 x 5,0		50	615,0	6,5	
NV 5 W16075			75	400,0	10,0	
NV 5 W16100			100	286,0	14,0	
NV 5 W19025	19,0	8,0	25	2.400,0	2,5	6.000
NV 5 W19040			40	1.333,0	4,5	
NV 5 W19050	 5,1 x 6,5		50	1.000,0	6,0	
NV 5 W19075			75	600,0	10,0	
NV 5 W19100			100	429,0	14,0	
NV 5 W25030	25,0	10,0	30	4.800,0	2,5	12.000
NV 5 W25050			50	2.400,0	5,0	
NV 5 W25075	 6,9 x 9,1		75	1.500,0	8,0	
NV 5 W25100			100	1.000,0	12,0	
NV 5 W25125			125	857,0	14,0	
NV 5 W32035	32,0	12,5	35	6.667,0	3,0	20.000
NV 5 W32050			50	3.636,0	5,5	
NV 5 W32075	 9,25x10,8		75	2.222,0	9,0	
NV 5 W32100			100	1.538,0	13,0	
NV 5 W32125			125	1.250,0	16,0	
NV 5 W32150			150	1.053,0	19,0	
NV 5 W38040	38,0	16,0	40	7.143,0	3,5	25.000
NV 5 W38050			50	5.000,0	5,0	
NV 5 W38075	 10,5 x 12,6		75	2.778,0	9,0	
NV 5 W38100			100	1.923,0	13,0	
NV 5 W38150			150	1.316,0	19,0	
NV 5 W38200			200	926,0	27,0	

W-Federn haben extrem hohe Federkräfte und sind ideal bei hoher Belastung und kleinen Arbeitshüben.

### Wichtig:

Der max. zulässige Arbeitsweg s-max (Vorspannung + Arbeitshub) DARF NIEMALS ÜBERSCHRITTEN WERDEN! Federwege, die über s-max liegen, können zu schweren Schäden führen.

W-Federn sowie Preise und Lieferzeiten auf Anfrage.

# NV 5 SFE Systemfedereinheiten

- Bestell-Nr.:** NV 5 SFE.00.d<sub>1</sub>xL<sub>1</sub> (ohne Feder)  
 NV 5 SFE.10.d<sub>1</sub>xL<sub>1</sub> (inkl. Systemfeder 1S Kennfarbe grün nach ISO 10243)  
 NV 5 SFE.20.d<sub>1</sub>xL<sub>1</sub> (inkl. Systemfeder 2S Kennfarbe blau nach ISO 10243)  
 NV 5 SFE.30.d<sub>1</sub>xL<sub>1</sub> (inkl. Systemfeder 3S Kennfarbe rot nach ISO 10243)  
 NV 5 SFE.40.d<sub>1</sub>xL<sub>1</sub> (inkl. Systemfeder 4S Kennfarbe gelb nach ISO 10243)

Die Systemfedereinheiten beinhalten folgende Einzelteile laut Tabelle:

Einzelteile	Bestell-Nr.	Beschreibung
Zylinderschraube	NV 5 M	nach DIN 912
Spannscheibe*	NV 5 SSS.d <sub>1</sub>	
Abstimmzscheibe*	NV 5 SAS.d <sub>1</sub>	
Distanzrohr	NV 5 DSR.	siehe Seite 25
Gewindescheibe*	NV 5 SGWS.d <sub>1</sub>	
Nachschleifscheibe*	NV 5 SNS.d <sub>1</sub>	

\* Werkstoff: Stahl, oberflächengehärtet

d <sub>1</sub>	L <sub>1</sub>	L <sub>2</sub>	s <sub>2</sub>	s <sub>4</sub>	d <sub>4</sub>	Zylinder- schraube	d <sub>2</sub>	L	Systemfeder (NV 5 1S-4S)	Bestell-Nr.- Ergänzung
20	39	9	4	8	13	M6 x 35	10	20	20 x 032	20 x 039
	49					30		20 x 044	20 x 049	
	69					50		20 x 064	20 x 069	
	82					63		20 x 076	20 x 082	
25	39	11	4	8	16	M8 x 35	12	20	25 x 032	25 x 039
	49					30		25 x 044	25 x 049	
	69					50		25 x 064	25 x 069	
	82					63		25 x 076	25 x 082	
	119					100		25 x 115	25 x 119	
32	49	13	4	10	19	M10 x 50	16	30	32 x 044	32 x 049
	69					50		32 x 064	32 x 069	
	82					63		32 x 076	32 x 082	
	119					100		32 x 115	32 x 119	
40	69	16	5	10	23	M12 x 70	20	50	40 x 064	40 x 069
	82					63		40 x 076	40 x 082	
	119					100		40 x 115	40 x 119	
50	69	20	5	10	28	M16 x 70	25	50	50 x 064	50 x 069
	82					63		50 x 076	50 x 082	
	119					100		50 x 115	50 x 119	

**Maßtabelle Einzelteile**

d <sub>1</sub>	d <sub>2</sub>	d <sub>3</sub>	d <sub>4</sub>	d <sub>5</sub>	d <sub>6</sub>	d <sub>7</sub>	d <sub>8</sub>	d <sub>9</sub>	s <sub>2</sub>	s <sub>3</sub>	s <sub>4</sub>	Nr.
20	10	M6	13	6,5	10,5	3,2	14	6,5	4	3	8	20
25	12	M8	16	8,5	13	4,2	18,5	8,5	4	3	8	25
32	16	M10	19	10,5	16,5	4,2	25	10,5	4	3	10	32
40	20	M12	23	12,5	20,5	4,2	30	12,5	5	4	10	40
50	25	M16	28	16,5	25,5	4,2	40	16,5	5	4	10	50

**Kraft - Weg - Tabelle**

d <sub>1</sub> x L <sub>1</sub>	LSF	V		mit Feder grün			mit Feder blau			mit Feder rot			mit Feder gelb		
		mm	%	F <sub>N</sub>	s Hub	F max	F <sub>N</sub>	s Hub	F max	F <sub>N</sub>	s Hub	F max	F <sub>N</sub>	s Hub	F max
20x039	32	2	6	90	10,8	576	145	9,2	813	336	6,7	1612	448	6,0	1792
20x049	44	4	9	120	13,6	528	190	11,4	731	448	9,2	1478	596	7,0	1639
20x069	64	4	6	80	21,6	512	129	18,4	723	288	15,2	1384	396	12,0	1584
20x082	76	3	4	48	27,4	486	75	23,6	667	179	19,8	1361	245	16,0	1552
25x039	32	2	6	160	10,8	1027	236	9,2	1321	594	7,6	2851	748	6,0	2995
25x049	44	4	9	211	13,6	931	323	11,4	1244	748	9,2	2468	976	7,0	2684
25x069	64	4	6	140	21,6	901	212	18,4	1187	492	15,2	2361	644	12,0	2576
25x082	76	3	4	84	27,4	851	129	23,6	1149	297	19,8	2257	392	16,0	2485
25x119	115	5	4	93	41,0	860	140	35,3	1128	325	29,5	2242	428	23,8	2468
32x049	44	4	9	318	13,6	1399	632	11,4	2433	1296	9,2	4276	1976	7,0	4668
32x069	64	4	6	312	21,6	1356	396	18,4	2217	848	15,2	4070	1076	12,0	4307
32x082	76	3	4	132	27,6	1337	241	23,6	2141	516	19,8	3921	655	16,0	4151
32x119	115	5	4	145	41,0	1334	257	35,3	2058	535	29,5	3691	700	23,8	4032
40x069	64	5	8	365	20,6	1868	700	17,4	3136	1345	14,2	5164	2435	11,0	7792
40x082	76	4	5	252	26,4	1915	432	22,6	2872	876	18,8	4993	1516	15,0	7201
40x119	115	6	5	237	40,0	1821	430	34,3	2893	852	28,5	4899	1470	22,8	7056
50x069	64	5	8	780	20,6	3993	1045	17,4	4681	2065	14,2	7929	3545	11,0	11344
50x082	76	4	5	500	26,4	3800	672	22,6	4468	1356	18,8	7729	2288	15,0	10868
50x119	115	6	5	486	40,0	3726	636	34,3	4271	1290	28,5	7417	2112	22,8	10137

**Erläuterungen:**

- LSF = Länge der Systemfeder in mm
- V = Vorspannung in mm und %
- F<sub>N</sub> = Vorspannkraft in N
- s Hub = max. Hub der vorgespannten Feder in mm
- F max = max. Federkraft in N

**Einbaubeispiel:**

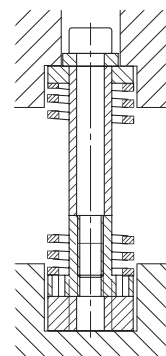

# NV 5 SSG Stahlscheiben gehärtet

Werkstoff: 1.1730 C45W

Härte: 45 – 50 HRC

Bestell-Nr.: NV 5 SSG.d<sub>1</sub>

Beispiel: NV 5 SSG.6,4

d <sub>1</sub>	d <sub>2</sub>	S
6,4	17	3
8,4	23	4
10,5	26	4
13	30	5
17	35	6
21	42	8
25	46	10

Weitere Abmessungen auf Anfrage.

Einbaubeispiel:

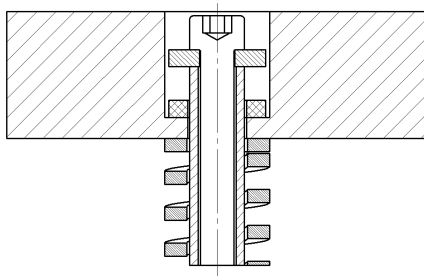

# NV 5 DSV Dämpfungsscheiben

Werkstoff: Polyurethan-Elastomer

Härte: 90 ± 5 Shore A

Toleranzen:

d<sub>1</sub> ± 0,5 mm

d<sub>2</sub> ± 0,3 mm

s ± 0,3 mm

Bestell-Nr.: NV 5 DSV.d<sub>1</sub>

Beispiel: NV 5 DSV.11

d <sub>1</sub>	d <sub>2</sub>	S
11	17	3
14	23	4
17	26	4
21	30	5
26	35	6
31	42	6
37	46	6

Einbaubeispiel:

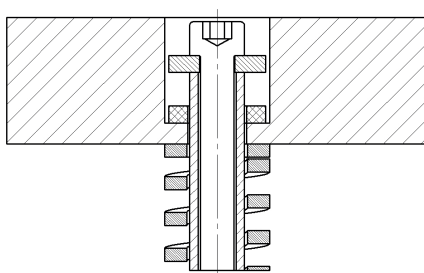

# NV 5 DSR Distanzrohre

Werkstoff: 1.0715 9 S Mn 28 K

Härte: 54 – 58 HRC einsatzgehärtet

Bestell-Nr.: NV 5 DSR.d<sub>2</sub>xL

Beispiel: NV 5 DSR.16x050

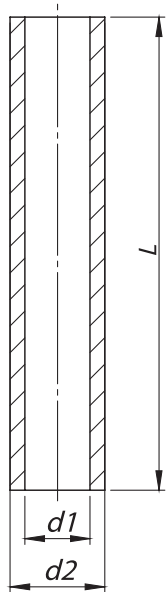

Einbaubeispiel:

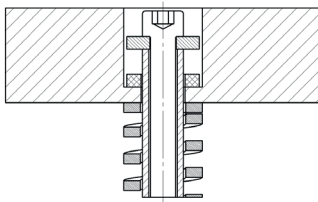

d <sub>1</sub>	d <sub>2</sub> h11	L± 0,1	NV 5 SSG	NV 5 DSV
7	10	20	6,4	11
		30		
		40		
		50		
		63		
		80		
		200		
		20		
8,4	12	27	8,4	14
		30		
		33		
		37		
		38		
		40		
		44		
		48		
		50		
		61		
		63		
		72		
		80		
		90		
		100		
200				
9	13	20	8,4	14
		30		
		40		
		50		
		63		
		80		
		100		
		120		
		200		
		220		
		250		
11	16	30	10,5	17
		33		
		40		
		44		
		48		
		50		
		60		
		61		
		63		
		72		
		73		
		80		
		90		
100				
125				
140				
150				
160				
200				
13	19	30	13	21
		40		
		50		
		60		
		63		
		80		
		100		
		125		
200				
13	20	30	13	21
		33		
		38		
		40		
		44		
		48		
		50		
		60		
		61		
		63		
		72		
		80		
		90		
100				
125				
150				
200				
220				
300				

d <sub>1</sub>	d <sub>2</sub> h11	L± 0,1	NV 5 SSG	NV 5 DSV
17	25	48	17	26
		50		
		60		
		61		
		63		
		70		
		72		
		80		
		90		
		95		
		100		
		105		
		115		
		125		
		135		
22	30	150	21	31
		165		
		175		
		195		
		200		
		215		
		225		
		235		
		250		
		255		
		300		
500				
22	32	50	-	-
		63		
		70		
		72		
		80		
		90		
		100		
23	35	120	-	-
		125		
		145		
		150		
		175		
		198		
		200		
26	36	225	25	37
		245		
		72		
		80		
		90		
		100		
		125		
		150		
250				

Lieferzeiten auf Anfrage.